



**BASIC MANUAL**

VHF/UHF ALL MODE TRANSCEIVER  
**IC-9700**



Thank you for choosing this Icom product. The IC-9700 VHF/UHF ALL MODE TRANSCEIVER is designed and built with Icom's state of the art technology and craftsmanship. With proper care, this product should provide you with years of trouble-free operation. We appreciate you making the IC-9700 your transceiver of choice, and hope you agree with Icom's philosophy of "technology first." Many hours of research and development went into the design of your IC-9700.

## IMPORTANT

**READ ALL INSTRUCTIONS** carefully completely before using the transceiver.

**SAVE THIS INSTRUCTION MANUAL**— This instruction manual contains basic operating instructions for the IC-9700. For advanced operating instructions, see the Advanced Manual for details. The Advanced Manual is available at the following internet address:  
<https://www.icomjapan.com/support/>

## FEATURES

- **RF Direct Sampling System**

The IC-9700 employs an RF direct sampling system. RF signals are directly converted to digital data in the ADC, and then processed in the FPGA. This system is a leading technology, marking an epoch in amateur radio. The 1200 MHz band uses a downconversion IF sampling.

- **Real-Time Spectrum Scope**

The spectrum scope is class-leading in resolution, sweep speed and dynamic range. When you touch the scope screen on the intended signal, the touched area is magnified. The large 4.3 inch color TFT touch LCD offers intuitive operation.

- **D-STAR operation**

The IC-9700 has the D-STAR Repeater (DR) function. Moreover, by using the DD mode, you can browse the Internet through a repeater station.

- **Satellite operation**

The IC-9700 has 99 satellite memory channels for both uplink and downlink frequencies and mode.

- **"IP+" Function**

The IP Plus function improves 3rd order intercept point (IP3) performance. When a weak signal is received adjacent to strong interference, the AD converter is optimized against signal distortion.

- **A 4.3 inch touch panel color display**

- **Multi-function control for easy settings**

## EXPLICIT DEFINITIONS

WORD	DEFINITION
⚠ <b>DANGER!</b>	Personal death, serious injury or an explosion may occur.
⚠ <b>WARNING!</b>	Personal injury, fire hazard or electric shock may occur.
<b>CAUTION</b>	Equipment damage may occur.
<b>NOTE</b>	Recommended for optimum use. No risk of personal injury, fire or electric shock.

## SUPPLIED ACCESSORIES

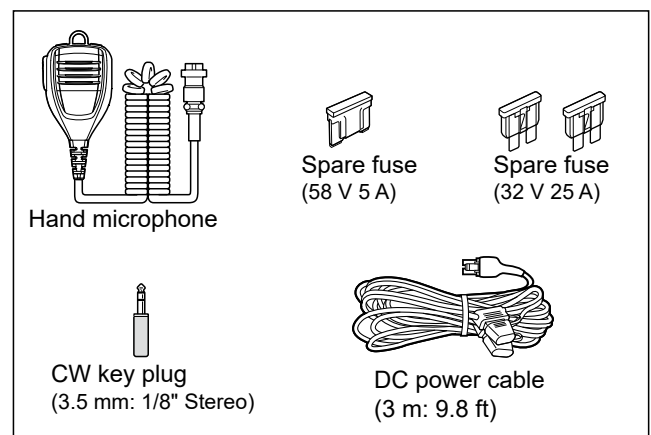

① Different types of accessories may be supplied, or may not be supplied depending on the transceiver version.

This product includes RTOS "RTX" software, and is licensed according to the software license.

This product includes "zlib" open source software, and is licensed according to the open source software license.

This product includes "libpng" open source software, and is licensed according to the open source software license.

This product includes "FreeType library" open source software, and is licensed according to the open source software license.

This software is based in part on the work of the Independent JPEG Group, and is licensed according to the open source software license.

Refer to the "About the Licenses" page at the end of this manual for information on the open source software "RTX," "zlib," and "libpng."

---

## FCC INFORMATION

---

This equipment has been tested and found to comply with the limits for a Class B digital device, pursuant to part 15 of the FCC Rules. These limits are designed to provide reasonable protection against harmful interference in a residential installation. This equipment generates, uses and can radiate radio frequency energy and, if not installed and used in accordance with the instructions, may cause harmful interference to radio communications. However, there is no guarantee that interference will not occur in a particular installation. If this equipment does cause harmful interference to radio or television reception, which can be determined by turning the equipment off and on, the user is encouraged to try to correct the interference by one or more of the following measures:

- Reorient or relocate the receiving antenna.
- Increase the separation between the equipment and receiver.
- Connect the equipment into an outlet on a circuit different from that to which the receiver is connected.
- Consult the dealer or an experienced radio/TV technician for help.

**CAUTION:** Changes or modifications to this device, not expressly approved by Icom Inc., could void your authority to operate this device under FCC regulations.

Icom is not responsible for the destruction, damage to, or performance of any Icom or non-Icom equipment, if the malfunction is because of:

- Force majeure, including, but not limited to, fires, earthquakes, storms, floods, lightning, or other natural disasters, disturbances, riots, war, or radioactive contamination.
- The use of Icom transceivers with any equipment that is not manufactured or approved by Icom.

---

## DISPOSAL

---



The crossed-out wheeled-bin symbol on your product, literature, or packaging reminds you that in the European Union, all electrical and electronic products, batteries, and accumulators (rechargeable batteries) must be taken to designated collection locations at the end of their working life. Do not dispose of these products as unsorted municipal waste. Dispose of them according to the laws in your area.

---

## ABOUT CE AND DOC

---

**CE** Hereby, Icom Inc. declares that the versions of IC-9700 which have the “CE” symbol on the product, comply with the essential requirements of the Radio Equipment Directive, 2014/53/EU, and the restriction of the use of certain hazardous substances in electrical and electronic equipment Directive, 2011/65/EU. The full text of the EU declaration of conformity is available at the following internet address:  
<https://www.icomjapan.com/support/>

These versions also comply with the essential requirements of the Battery Regulation, (EU) 2023/1542.

---

## ABOUT UKCA DOC

---

To obtain the UKCA Declaration of Conformity, please contact Icom UK Limited by email at [info@icomuk.co.uk](mailto:info@icomuk.co.uk) or alternatively call + 44(0) 1227 741741.

---

## TRADEMARKS

---

Icom and the Icom logo are registered trademarks of Icom Incorporated (Japan) in Japan, the United States, the United Kingdom, Germany, France, Spain, Russia, Australia, New Zealand and/or other countries. Microsoft and Windows are trademarks of the Microsoft group of companies. AMBE+2 is a trademark and property of Digital Voice Systems Inc. All other products or brands are registered trademarks or trademarks of their respective holders.

---

## ABOUT THE TOUCH SCREEN

### ◇ Touch operation

In the Advanced manual or Basic manual, the touch operation is described as shown below, with the beep tone ON.



#### **Touch**

If the display is touched briefly, one short beep sounds.



#### **Touch for 1 second**

If the display is touched for 1 second, one short and one long beep sound.

### ◇ Touch screen precautions

- The touch screen may not properly work when the LCD protection film or sheet is attached.
- Touching the screen with your finger nails, sharp-tipped object and so on, or touching the screen hard may damage it.
- Tablet PC operations such as flick, pinch in and pinch out cannot be performed on this touch screen.

### ◇ Touch screen maintenance

- If the touch screen becomes dusty or dirty, wipe it clean with a soft, dry cloth.
- When you wipe the touch screen, be careful not to push it too hard or scratch it with your finger nails. Otherwise you may damage the screen.

---

## ABOUT THE MANUALS

The following manuals or Guide for this transceiver are published at the following internet address:  
<https://www.icomjapan.com/support/>

#### • **Advanced Manual (English)**

Instructions for advanced operations in English.

#### • **Basic Manual**

Instructions for basic operations, the same as this manual.

#### • **CI-V Reference Guide (English)**

Describes the control commands used in remote control operation (serial communication with CI-V).

#### • **About the Share Pictures function (English)**

Describes how to use the Share Pictures function in English.

#### **For Reference**

#### • **HAM Radio Terms (English)**

A glossary of HAM radio terms in English.

---

## VOICE CODING TECHNOLOGY

The AMBE+2™ voice coding Technology embodied in this product is protected by intellectual property rights including patent rights, copyrights and trade secrets of Digital Voice Systems, Inc. This voice coding Technology is licensed solely for use within this Communications Equipment.

The user of this Technology is explicitly prohibited from attempting to extract, remove, decompile, reverse engineer, or disassemble the Object Code, or in any other way convert the Object Code into a human-readable form. U.S. Patent No. #8,359,197.

# ABOUT THE INSTRUCTIONS

The Advanced and Basic manuals are described in the following manner.

## “ ” (Quotation marks):

Used to indicate icons, setting items, and screen titles displayed on the screen.

The screen titles are also written in uppercase letters. (Example: FUNCTION screen)

## [ ] (brackets):

Used to indicate keys.

## Routes to the Set modes and Setting screens

Routes to the Set mode, Setting screens and the setting items are described in the following manner.

**MENU** » **SET > Display > Display Type**

### Instruction example

#### ◇ Selecting the display background

1. Select the “Display Type” screen.

**MENU** » **SET > Display > Display Type**

2. Select the desired background between A and B by rotating and then pushing **MULTI**.

## Detailed instruction

1. Push **MENU**.

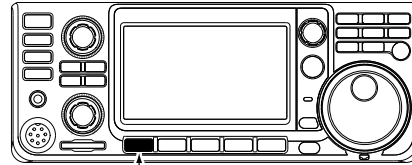

Push

- Opens the MENU screen.

2. Touch **[SET]**.



MENU screen

- Opens the SET screen.

3. Rotate **MULTI**, and then push **MULTI** to select “Display.”

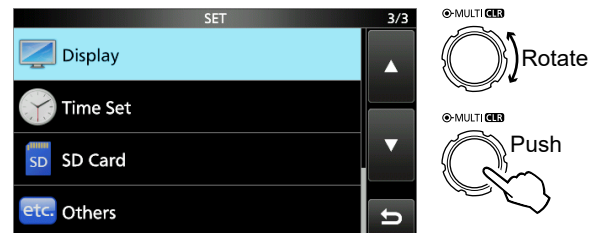

SET screen

4. Rotate **MULTI**, and then push **MULTI** to select “Display Type.”

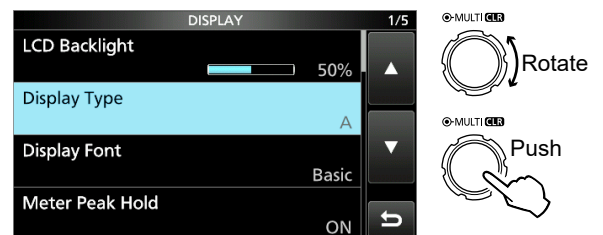

DISPLAY screen

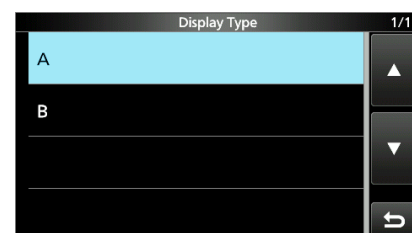

“Display Type” screen

# TABLE OF CONTENTS

IMPORTANT.....	i	◇ About the Auto Tuning Step function .....	3-5
FEATURES.....	i	◇ Directly entering a frequency .....	3-5
EXPLICIT DEFINITIONS.....	i	◇ Band Edge Beep.....	3-6
SUPPLIED ACCESSORIES.....	i	◇ Entering a Band Edge.....	3-7
FCC INFORMATION .....	ii	RF gain and SQL level .....	3-10
DISPOSAL.....	ii	Dial Lock function .....	3-10
ABOUT CE AND DOC.....	ii	Adjusting the transmit output power .....	3-10
ABOUT UKCA DOC .....	ii	◇ Adjusting the transmit output power .....	3-10
TRADEMARKS.....	ii	Transmit Power Limit function .....	3-10
ABOUT THE TOUCH SCREEN .....	iii	Meter display .....	3-11
VOICE CODING TECHNOLOGY .....	iii	◇ Meter display selection .....	3-11
ABOUT THE MANUALS.....	iii	◇ Multi-function meter .....	3-11
ABOUT THE INSTRUCTIONS .....	iv	Adjusting the microphone gain .....	3-11
PRECAUTIONS.....	vii		
<b>1 PANEL DESCRIPTION.....</b>	<b>1-1</b>	<b>4 RECEIVING AND TRANSMITTING.....</b>	<b>4-1</b>
Front panel .....	1-1	Preamplifiers .....	4-1
Rear panel.....	1-3	Attenuator.....	4-1
Touch screen display.....	1-4	RIT function .....	4-1
◇ FUNCTION screen .....	1-6	◇ RIT monitor function .....	4-1
◇ MENU screen .....	1-6	CW Auto Tuning function.....	4-1
◇ QUICK MENU.....	1-6	AGC function control .....	4-2
◇ Multi-function menus.....	1-7	◇ Selecting the AGC time constant	
Multi-function dial .....	1-7	preset value .....	4-2
Keyboard entering and editing .....	1-8	◇ Setting the AGC time constant.....	4-2
◇ Entering and editing characters.....	1-8	Using the Digital Twin PBT.....	4-3
◇ Keyboard types.....	1-9	Selecting the IF filter.....	4-4
◇ Entering and editing.....	1-9	Selecting the IF filter shape.....	4-4
◇ Entering and editing example .....	1-10	Noise Blanker .....	4-5
		◇ Adjusting the NB level and time.....	4-5
		Noise Reduction .....	4-6
		◇ Adjusting the Noise Reduction level .....	4-6
		Notch Filter .....	4-6
		◇ Selecting the Notch filter type .....	4-6
		◇ Setting the Manual Notch filter.....	4-6
		Monitor function.....	4-7
		IP Plus function .....	4-7
		Setting the Speech Compressor .....	4-8
		◇ Setting before using the Speech	
		Compressor function.....	4-8
		◇ Using the Speech Compressor function ....	4-8
		AFC function.....	4-8
		Split frequency operation.....	4-9
		◇ Using the Quick Split function.....	4-9
		◇ Using the receive and transmit	
		frequencies set to VFO A and VFO B .....	4-9
		Split Lock function .....	4-10
		Setting the transmit filter width .....	4-10
		Operating CW.....	4-10
		◇ Setting the CW pitch control .....	4-10
		◇ Setting the key speed .....	4-10
		◇ Using the Break-in function.....	4-11
		◇ Monitoring the CW side tone .....	4-11
		◇ About the electronic Keyer function .....	4-12

<b>5</b>	<b>SCOPE OPERATION</b> .....	<b>5-1</b>	<b>9</b>	<b>CLOCK</b> .....	<b>9-1</b>
	Spectrum scope screen.....	5-1		Setting the date and time .....	9-1
	◇ Using the Spectrum Scope .....	5-1		◇ Setting the date.....	9-1
	◇ Center mode .....	5-2		◇ Setting the current time.....	9-1
	◇ Fixed mode .....	5-2		◇ Setting the UTC offset .....	9-1
	◇ Scroll mode.....	5-2		NTP function.....	9-1
	◇ Marker.....	5-2		◇ Using the NTP Time Synchronize function..	9-1
	◇ Touch screen operation .....	5-3		◇ Using the NTP function.....	9-1
	◇ Mini scope screen.....	5-3	<b>10</b>	<b>MAINTENANCE</b> .....	<b>10-1</b>
	Audio scope screen.....	5-3		Cleaning .....	10-1
<b>6</b>	<b>SD CARD</b> .....	<b>6-1</b>		Replacing fuse.....	10-1
	About the SD cards .....	6-1		Resetting .....	10-2
	Saving data .....	6-1		◇ Partial reset.....	10-2
	Inserting.....	6-1		◇ All reset.....	10-2
	Formatting .....	6-1		Cloning .....	10-3
	Unmounting.....	6-2		Touch screen calibration function .....	10-5
	Saving the setting data.....	6-2		Troubleshooting.....	10-6
	Loading the saved data.....	6-3		◇ D-STAR operation.....	10-8
	Deleting a data file.....	6-4	<b>11</b>	<b>SPECIFICATIONS</b> .....	<b>11-1</b>
	Displaying the card information.....	6-4		◇ General .....	11-1
	Importing or Exporting a CSV format file.....	6-5		◇ Transmitter .....	11-2
	◇ Importing.....	6-5		◇ Receiver.....	11-3
	◇ Exporting.....	6-6	<b>12</b>	<b>OPTIONS</b> .....	<b>12-1</b>
	About the SD card folders .....	6-7		Options .....	12-1
<b>7</b>	<b>SATELLITE COMMUNICATION</b> .....	<b>7-1</b>		Mounting the MB-118 .....	12-2
	Satellite communications outline.....	7-1		Attaching the MB-123.....	12-2
	Selecting the satellite mode .....	7-1	<b>13</b>	<b>CONNECTOR INFORMATION</b> .....	<b>13-1</b>
	◇ Setting the satellite VFO .....	7-1		[ACC].....	13-1
	◇ Selecting NOR/REV tracking.....	7-1		[DC 13.8 V].....	13-1
	Loop test procedure .....	7-2		[PHONES].....	13-1
	Satellite operation.....	7-3		[KEY] .....	13-2
	Satellite memories.....	7-3		[EXT-SP MAIN] / [EXT-SP SUB].....	13-2
	◇ Satellite memory screen .....	7-3		[USB] .....	13-2
<b>8</b>	<b>SET MODE</b> .....	<b>8-1</b>		[LAN] .....	13-2
	Set mode description.....	8-1		[DATA] .....	13-2
	Tone Control/TBW .....	8-2		[MIC].....	13-3
	Function.....	8-2		[REMOTE].....	13-3
	My Station .....	8-6		[REF IN 10MHz] .....	13-3
	DV/DD Set.....	8-9		[144MHz ANT] .....	13-3
	DV Repeater Monitor Set .....	8-10		[430MHz ANT] .....	13-3
	QSO/RX Log .....	8-11		[1200MHz ANT] .....	13-3
	Connectors.....	8-14		<b>ABOUT THE LICENSES</b> .....	<b>I</b>
	Network .....	8-18		<b>INDEX</b> .....	<b>II</b>
	Display.....	8-19			
	Time Set.....	8-21			
	SD Card.....	8-22			
	Others.....	8-23			

---

## PRECAUTIONS

---

⚠ **DANGER HIGH RF VOLTAGE! NEVER** touch an antenna or antenna connector while transmitting. This could cause an electric shock or burn.

⚠ **DANGER! NEVER** operate the transceiver near unshielded electrical blasting caps or in an explosive atmosphere. This could cause an explosion and death.

⚠ **WARNING RF EXPOSURE!** This device emits Radio Frequency (RF) energy. Extreme caution should be observed when operating this device. If you have any questions regarding RF exposure and safety standards please refer to the Federal Communications Commission Office of Engineering and Technology's report on Evaluating Compliance with FCC Guidelines for Human Radio Frequency Electromagnetic Fields (OET Bulletin 65).

⚠ **WARNING! NEVER** operate the transceiver with a headset or other audio accessories at high volume levels. If you experience a ringing in your ears, reduce the volume or discontinue use.

⚠ **WARNING! NEVER** apply AC power to the [DC13.8V] socket on the transceiver rear panel. This could cause a fire or damage the transceiver.

⚠ **WARNING! NEVER** apply more than 16 V DC to the [DC13.8V] socket on the transceiver rear panel. This could cause a fire or damage the transceiver.

⚠ **WARNING! NEVER** reverse the DC power cable polarity. This could cause a fire or damage the transceiver.

⚠ **WARNING! NEVER** remove the fuse holder on the DC power cable. Excessive current caused by a short could cause a fire or damage the transceiver.

⚠ **WARNING! NEVER** let metal, wire or other objects contact the inside of the transceiver, or make incorrect contact with connectors on the rear panel. This could cause an electric shock or damage the transceiver.

⚠ **WARNING! NEVER** operate or touch the transceiver with wet hands. This could cause an electric shock or damage to the transceiver.

⚠ **WARNING! NEVER** operate the equipment if you notice an abnormal odor, sound or smoke. Immediately turn OFF the power and/or remove the DC power cable. Contact your Icom dealer or distributor for advice.

⚠ **WARNING! NEVER** put the transceiver on an unstable place where the transceiver may suddenly move or fall. This could cause an injury or damage the transceiver.

⚠ **WARNING! NEVER** operate the transceiver during a lightning storm. It may result in an electric shock, cause a fire or damage the transceiver. Always disconnect the power source and antenna before a storm.

**CAUTION: DO NOT** expose the transceiver to rain, snow or any liquids. They could damage the transceiver.

**CAUTION: DO NOT** change the internal settings of the transceiver. This could reduce transceiver performance and/or damage to the transceiver. The transceiver warranty does not cover any problems caused by unauthorized internal adjustments.

**CAUTION: DO NOT** install or place the transceiver in a place without adequate ventilation, or block any cooling vents on the top, rear, sides or bottom of the transceiver. Heat dissipation may be reduced and damage the transceiver.

**CAUTION: NEVER** use harsh solvents such as Benzine or alcohol when cleaning. This could damage the transceiver surfaces. If the surface becomes dusty or dirty, wipe it clean with a soft, dry cloth.

**CAUTION: NEVER** leave the transceiver in areas with temperatures below  $-10^{\circ}\text{C}$  ( $+14^{\circ}\text{F}$ ) or above  $+60^{\circ}\text{C}$  ( $+140^{\circ}\text{F}$ ) for mobile operations.

**CAUTION: DO NOT** place the transceiver in excessively dusty environments. This could damage the transceiver.

**CAUTION: DO NOT** place the transceiver against walls or putting anything on top of the transceiver. This may overheat the transceiver.

**CAUTION: DO NOT** set the transceiver's RF output power to more than a connected linear amplifier's maximum input level. Otherwise, the linear amplifier will be damaged.

**CAUTION: DO NOT** use non-Icom microphones. Other microphones have different pin assignments, and may damage the transceiver.

**NEVER** place the transceiver in an insecure place to avoid inadvertent use by unauthorized persons.

**BE CAREFUL!** The transceiver will become hot when operating the transceiver continuously for long periods of time.

Turn OFF the transceiver's power and/or disconnect the DC power cable when you will not use the transceiver for long period of time.

The LCD display may have cosmetic imperfections that appear as small dark or light spots. This is not a malfunction or defect, but a normal characteristic of LCD displays.

Operate the transceiver that complies with your local laws and regulations. Depending on countries and/or regions, transceiver's output power and/or operations on specific frequencies may be restricted to avoid interferences with existing radio stations or services.

## Front panel

This section describes the keys, controls and dials that you use to operate the IC-9700. Refer to the pages posted beside each key, control, or dial for details.

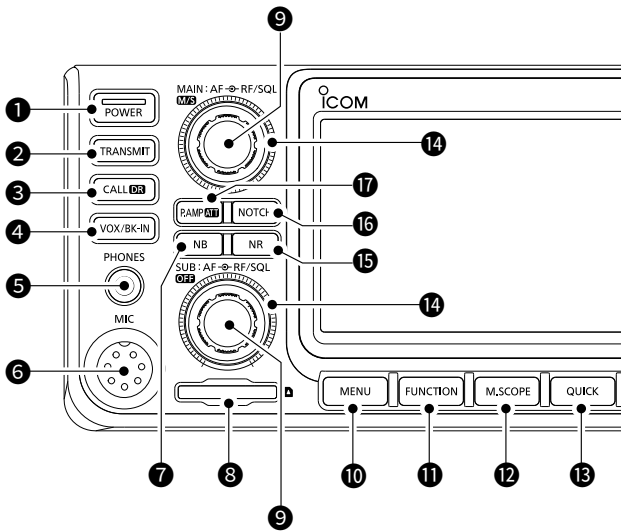

### 1 POWER KEY **POWER** (p. 3-1)

Turns the transceiver ON or OFF.

### 2 TRANSMIT KEY **TRANSMIT** (p. 3-10)

- Toggles between transmit and receive.
- In the DD mode, turns the TX Inhibit function ON or OFF.

### 3 CALL/DR FUNCTION KEY **CALL/DR** (p. 3-1)

- Push to toggle between the Call channel mode and the VFO/Memory modes.
- Hold down for 1 second to turn the DR function ON or OFF.

### 4 VOX/BREAK-IN KEY **VOX/BK-IN**

Turns the VOX function and Break-in function (p. 4-11) ON or OFF.

### 5 HEADPHONE JACK [PHONES] (p. 13-1)

Connects to standard stereo headphones.

### 6 MICROPHONE CONNECTOR [MIC] (p. 13-3)

Connects to the supplied or an optional microphone.

### 7 NOISE BLANKER KEY **NB** (p. 4-5)

Turns the Noise Blanker ON or OFF.

### 8 SD CARD SLOT [SD CARD] (p. 6-1)

Accepts an SD card.

### 9 VOLUME CONTROL **AF**/**RF/SQ**/**M/S**/**OFF** (p. 3-1)

- Adjust the audio output level.
- Push to select the Main or Sub band.
- Hold down **M/S** (upper) for 1 second to toggle between the Main and Sub band's frequency and operating modes.
- Hold down **OFF** (lower) for 1 second to turn the Dualwatch function ON or OFF.
- ① The upper control is for the Main band, and the lower control is for the Sub band.

### 10 MENU KEY **MENU** (p. 1-6)

Opens the MENU screen.

### 11 FUNCTION KEY **FUNCTION** (p. 1-6)

Opens the FUNCTION screen.

### 12 MINI SCOPE KEY **M.SCOPE** (p. 5-3)

- Displays the Mini scope or Spectrum scope.
- ① The Mini scope is displayed only when the Dualwatch function is OFF.

### 13 QUICK KEY **QUICK** (p. 1-6)

Opens the QUICK MENU screen.

### 14 RF GAIN CONTROL/SQUELCH CONTROL **AF**/**RF/SQ** (p. 3-10)

- Adjusts the RF gain and squelch threshold levels.
- ① The upper control is for the Main band, and the lower control is for the Sub band.

### 15 NOISE REDUCTION KEY **NR** (p. 4-6)

Turns the Noise Reduction function ON or OFF.

### 16 NOTCH KEY **NOTCH** (p. 4-6)

Turns ON or OFF, and selects the Notch function type.

### 17 PREAMP/ATTENUATOR KEY **P.AMP/ATT** (p. 4-1)

Turns ON or OFF, and selects one of two receive RF preamplifiers or turns the Attenuator ON or OFF.

# 1 PANEL DESCRIPTION

## Front panel (Continued)

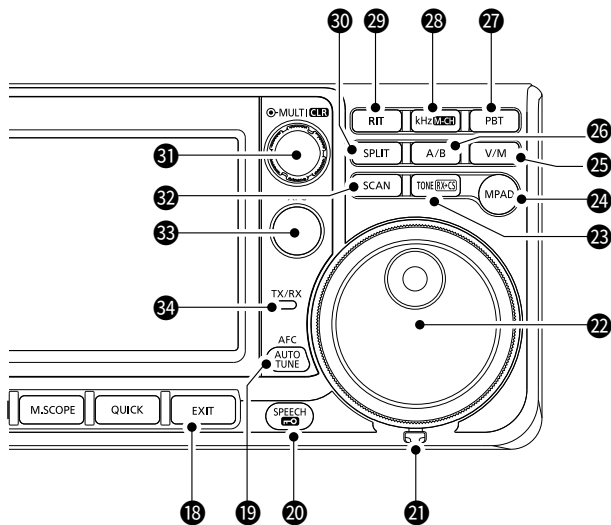

### 18 EXIT KEY **EXIT** (p. 1-6)

Exits a setting screen or returns to the previous screen.

### 19 AFC/AUTO TUNE KEY **AFC/AUTO TUNE** (p. 4-1)

- In the FM or DV mode, turns the Auto Frequency Control function ON or OFF.
- In the CW mode, automatically tunes the operating frequency to a close-by CW signal.

### 20 SPEECH/LOCK KEY **SPEECH/LOCK** (p. 3-10)

Announces the operating frequency or receiving mode, or electronically locks **MAIN DIAL**.

### 21 FRICTION ADJUSTER

Adjusts the friction of **MAIN DIAL**.

### 22 MAIN DIAL **MAIN DIAL** (p. 3-4)

Changes the operating frequency.

### 23 TONE/RX CALL SIGN CAPTURE KEY **TONERX-CS**

- In the FM mode, displays the Tone Set window.  
**For European versions:** While holding down [PTT], hold down this key to send the 1750 Hz tone.
- In the DV mode, push to display the RX History list, or hold down for 1 second to capture the latest received call sign (station or repeater) as a temporary call destination.

### 24 MEMO PAD KEY **MPAD**

Sequentially calls up the contents in the Memo Pads, or saves the displayed contents into the Memo Pad.

### 25 VFO/MEMORY KEY **V/M** (p.3-1)

Switches between the VFO and Memory mode, or copies the memory channel contents to the VFO.

### 26 A/B KEY **A/B** (p. 3-1)

Switches between VFO A and VFO B, or copies the selected VFO's frequency, mode and filter settings to the other VFO.

### 27 PASSBAND TUNING CONTROL KEY **PBT** (p. 4-3)

Enables **MULTI** to adjust the Passband Tuning Control (PBT).

### 28 kHz TUNING STEP/M-CH KEY **KHzM-CH** (p. 1-7)

In the VFO mode, push to enable **MULTI** to adjust the kHz Tuning Control, or hold down for 1 second to enable **MULTI** to select the Memory Channel.

- ① In the Memory or Call channel mode, it only enables the Memory channel selection.

### 29 RIT KEY **RIT** (p. 4-1)

Enables **MULTI** to adjust the Receiver Incremental Tuning (RIT), and it turns the Receiver Incremental Tuning (RIT) function ON or OFF.

### 30 SPLIT KEY **SPLIT** (p. 4-9)

Turns the Split function ON or OFF.

### 31 MULTI-FUNCTION CONTROL **MULTI/CLR** (p. 1-7)

- Displays the Multi-function menu for various adjustments, or selects a desired item.
- Hold down for 1 second to clear the RIT shift frequency or the PBT setting.

### 32 SCAN KEY **SCAN**

- Push to display the Scan Select window.
- Hold down for 1 second to start the previously selected scan.

### 33 TRANSMIT FREQUENCY CHECK KEY **XFC** (p. 4-1)

- In the Split or Duplex mode, enables you to monitor the transmit frequency while holding the key down.
- In the Simplex mode, temporarily opens the squelch and cancels the noise reduction function while holding the key down.
- ① In the DV mode, enables you to monitor signals in the FM or DV mode, depending on the Digital Monitor setting.

### 34 TX/RX INDICATOR (p. 3-10)

Lights red while transmitting and lights green while receiving.

**Rear panel**

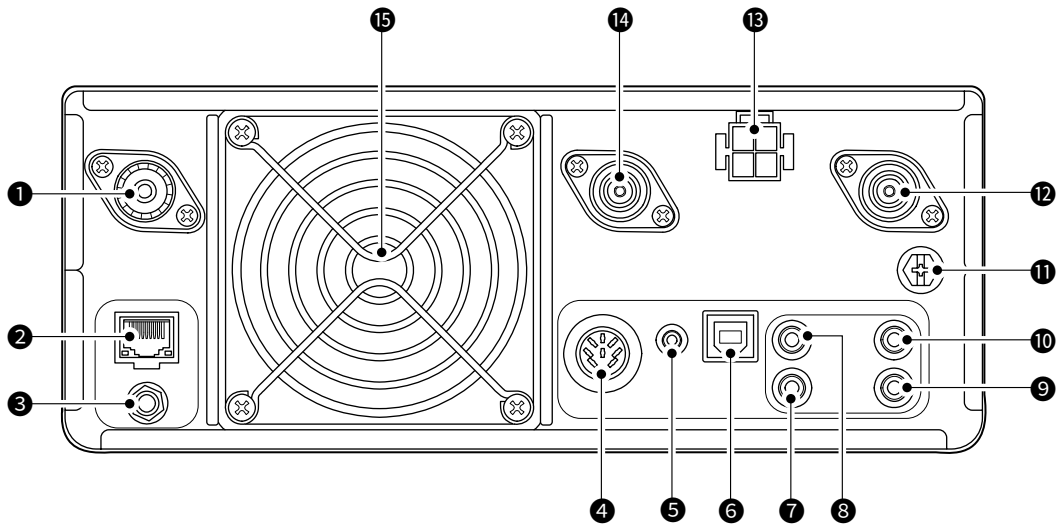

**1 ANTENNA CONNECTOR [144 MHz ANT] (p. 13-3)**  
Connects to a 50 Ω PL-259 coax connector.

**2 ETHERNET CONNECTOR [LAN] (p. 13-2)**  
Connects to a PC network through a LAN.

**3 REFERENCE SIGNAL INPUT [REF IN 10 MHz] (p. 13-3)**  
Inputs a 10 MHz reference signal through the SMA connector.

**4 SOCKET [ACC] (p. 13-1)**  
Connects to devices to control an external unit or to control the transceiver.

**5 DATA JACK [DATA] (p. 13-2)**  
Connects to devices to control an external unit or to control the transceiver with 2.5 mm (1/10") stereo plug.

**6 USB PORT (B TYPE) [USB] (p. 13-2)**  
Connects to a PC.

**7 KEY JACK [KEY] (p. 13-2)**  
Connects to a straight key, paddle, or an external electronic keyer with 3.5 mm (1/8") stereo plug.

**8 CI-V REMOTE CONTROL JACK [REMOTE] (p. 13-3)**  
Connects to a PC or other transceiver for external control.

**9 EXTERNAL SPEAKER JACK [EXT-SP SUB]**

**10 EXTERNAL SPEAKER JACK [EXT-SP MAIN] (p. 13-2)**  
Accepts a 4~8 Ω external speaker with 3.5 mm (1/8") mono plugs.

**11 GROUND TERMINAL [GND] (p. 2-1)**  
Connects to ground to prevent electric shocks, TVI, BCI and other problems.

**12 ANTENNA CONNECTOR [1200 MHz ANT] (p. 13-3)**  
Connects to a 50 Ω Type N coax connector for the 1.2 GHz band.

**13 DC POWER SOCKET [DC 13.8 V] (pp. 2-1 and 13-1)**  
Accepts 13.8 V DC through the DC power cable.

**14 ANTENNA CONNECTOR [430 MHz ANT] (p. 13-3)**  
Connects to a 50 Ω Type N coax connector for the 440 MHz band.

**15 COOLING FAN**  
Cools the PA unit when necessary.

## Touch screen display

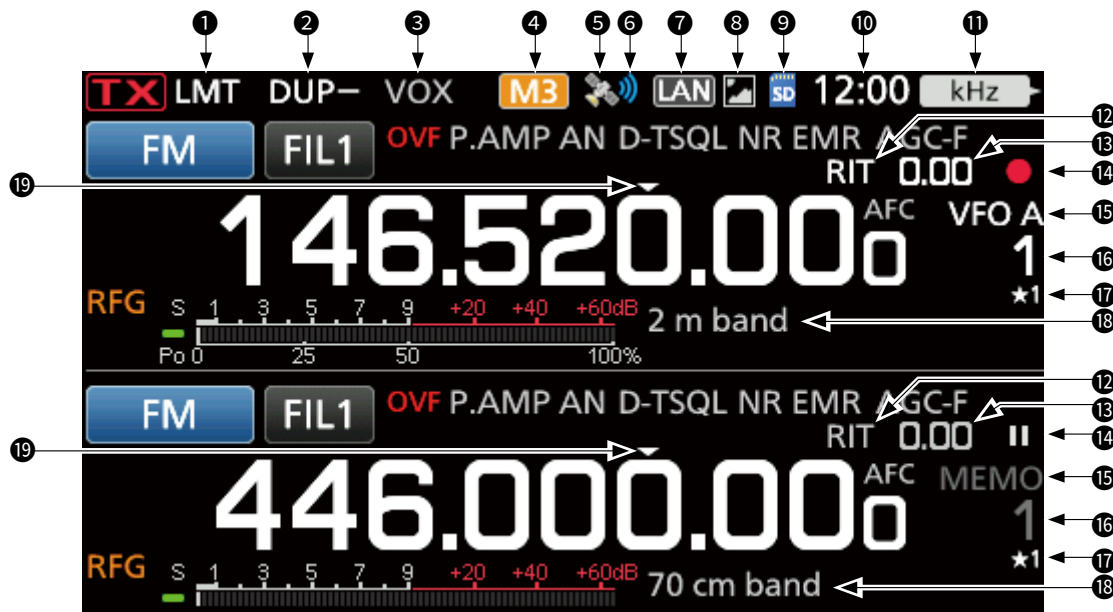

**1 LMT ICON [LMT]**

Displayed if the power amplifier temperature becomes extremely high, and the Protection function is activated after transmitting continuously for a long period of time.

**2 DUPLEX/SPLIT/REPEATER MODE/INTERNAL GATEWAY ICONS [DUP-] / [SPLIT] / [RPS] / [ ]**

Displays "DUP" when the Duplex mode is ON.  
 Displays "SPLIT" when the Split function is ON.  
 Displays "RPS" while using the Repeater Simplex mode (RPS) in the DD mode.  
 Displays "[ ]" while using the Internal Gateway function.

**3 BK-IN/F-BKIN/VOX INDICATORS [F-BKIN] / [VOX]**

Displayed while the Semi Break-in, Full Break-in or VOX function is ON.

**4 M1~M8/T1~T8/SPEECH COMPRESSOR ICONS [M1] / [T1] / [COMP]**

Displays "M1"~"M8" while "External Keypad" on the CONNECTORS screen is set to ON and you are using the Memory Keyer function (p. 4-12).  
 Displays "T1"~"T8" while using the Voice TX memory.  
 Displays "COMP" when the Speech Compressor function is ON.

**5 GPS ICON [ ]**

Displays the status of the connected GPS receiver. Touch the icon to display the GPS INFORMATION screen.

**6 GPS ALARM ICON [ ]**

Displayed when the GPS Alarm function is ON.

**7 NETWORK CONTROL ICON [LAN]**

Displayed while the transceiver and the optional RS-BA1 are connected through a LAN cable for Remote control operation.

**8 PICTURE SHARE ICON [ ]**

Displayed when the Share Pictures function is ON.

**9 SD CARD ICON [SD] (p. 6-1)**

Displayed when an SD card is inserted, and blinks while accessing the SD card.

**10 CLOCK READOUT [12:00] (p. 9-1)**

Displays the current local time.  
 Touch the readout to display both the current local time and UTC time.

**11 FUNCTION INDICATOR FOR MULTI-FUNCTION CONTROL**

Displays the function that is assigned to [MULTI].

**12 RIT ICON [RIT] (p. 4-1)**

Displayed when the RIT function is ON.

**13 RIT/DUPLEX OFFSET FREQUENCY READOUT**

Displays the shift offset frequency for the RIT or Duplex functions, while these functions are ON.

**14 VOICE RECORDER ICONS [ ] / [ ]**

Displayed while recording or pausing the Voice recorder.

**15 VFO/MEMORY ICONS [MEMO] (p. 3-1)**

Displays "VFO A" or "VFO B" when the VFO mode is selected, and displays "MEMO" when the Memory mode is selected.

**16 MEMORY CHANNEL READOUT [1]**

Displays the selected memory channel number.

**17 SELECT MEMORY CHANNEL ICON**

Indicates that the displayed memory channel is assigned as a Select Memory channel (★1~★3).

**18 MEMORY NAME**

Displayed when the Memory name is entered.

**19 QUICK TUNING ICON [ ]**

Displayed when the Quick Tuning Step function is ON.

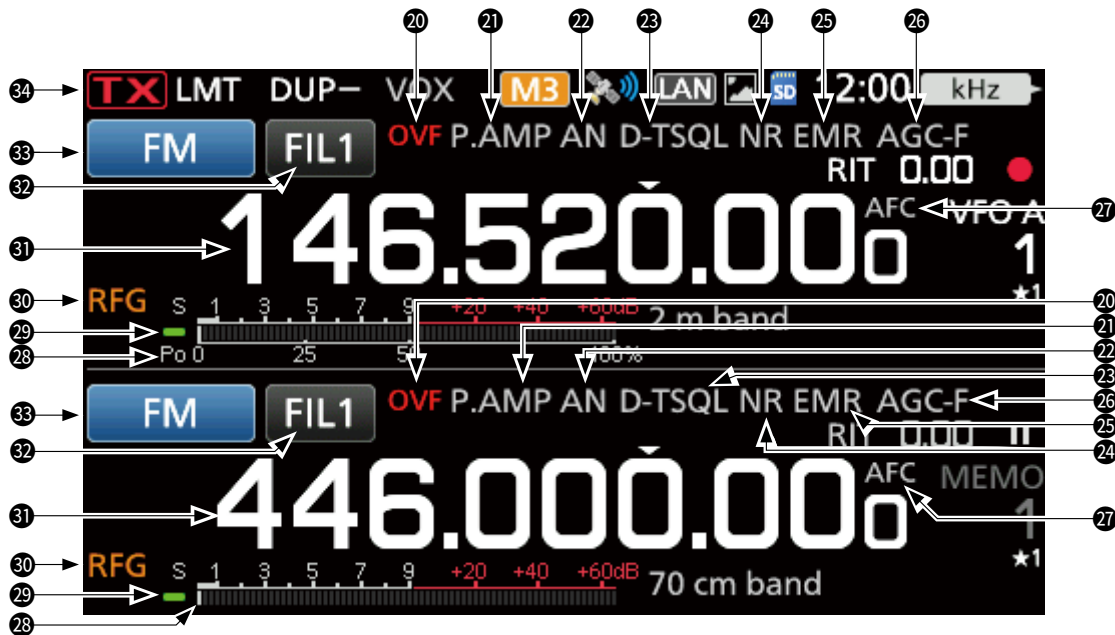

- 20 OVF ICON OVF** (p. 3-10)  
 Displayed when an excessively strong signal is received.
- 21 PREAMPLIFIER/ATTENUATOR ICONS (p. 4-1)**  
P.AMP/ATT  
 Displayed when one of the Preamplifiers is ON, or the Attenuator is ON.
- 22 NOTCH INDICATOR (p. 4-6)**  
 Displays “AN” when the Auto Notch function is ON, and “MN” is displayed when the Manual Notch function is ON.
- 23 NOISE BLANKER/TONE/DIGITAL SQUELCH ICONS NB/D-TSQL** (p. 4-5)  
 Displayed when the Noise Blanker function is ON, when various tone functions are ON, or when various digital squelch functions are ON.
- 24 NOISE REDUCTION/AUTO TUNE INDICATORS**  
 Displays “NR” when the Noise Reduction function is ON. (p. 4-6)  
 Displays “AUTOTUNE” when the Auto Tuning function is ON.
- 25 EMR/BK/PACKET LOSS/AUTO REPLY ICONS EMR/BK/L/A**  
 Displayed when the EMR (Enhanced Monitor Request) function is ON, when the BK (Break-in) function is ON, when Packet loss has occurred, or when the Automatic Reply function is ON.
- 26 AGC ICON AGC-F** (p. 4-2)  
 Displayed while the Auto Gain Control (AGC) is ON.
- 27 AFC / 1/4 ICON AFC / 1/4** (pp. 3-5, 8-5)  
 “AFC” is displayed while the Auto Frequency Control (AFC) is ON. (p. 8-5)  
 “1/4” is displayed while the 1/4 Tuning function is ON. (p. 3-5)
- 28 MULTI-FUNCTION METER (p. 3-11)**  
 Displays various values and levels, depending on the function that you selected.
- 29 RX STATUS INDICATOR**  
 Lights green when a signal is received, or the squelch is open.
- 30 RF GAIN ICON RFG** (p. 3-10)  
 Displayed when AF↔RF/SQL (outer) is set to the counterclockwise from the 11 o’clock position. The icon indicates that the RF gain is reduced.
- 31 MAIN BAND FREQUENCY READOUT  
 SUB BAND FREQUENCY READOUT (p. 3-2)**  
 Displays the transmit or receive frequency for the Main and Sub bands.
- 32 IF FILTER INDICATOR FIL2** (p. 4-4)  
 Displays the selected IF filter number.  
 A dot “.” is displayed on the IF Filter Indicator when you change the IF passband width.
- 33 MODE INDICATOR RTTY-R** (p. 3-3)  
 Displays the selected operating mode.
- 34 TX STATUS INDICATOR TX**  
 Displays the transmit status of the displayed frequency.
 
  - TX is displayed while transmitting.
  - TX is displayed when the selected frequency is outside of the band edge frequency range.(p. 3-6)
  - TX is displayed when transmission is inhibited (p. 3-10)

# 1 PANEL DESCRIPTION

## Touch panel (Continued)

### ◇ FUNCTION screen

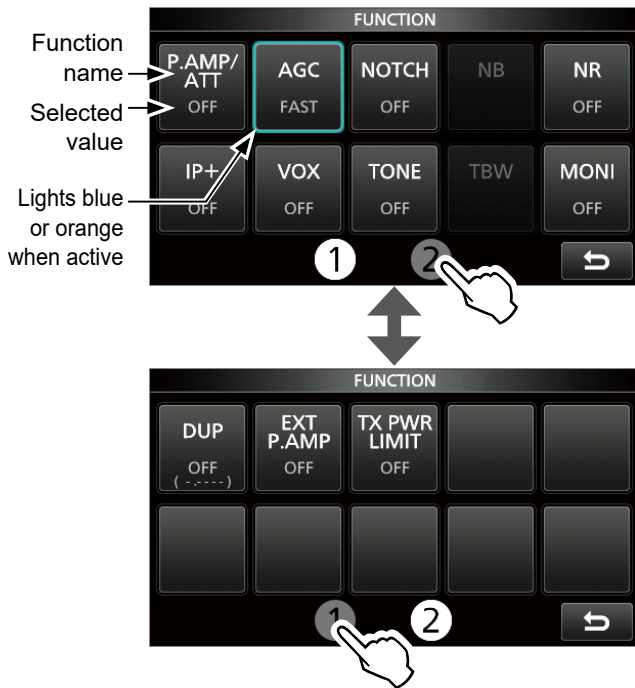

### ◇ MENU screen



- Push **FUNCTION** to open the FUNCTION screen in the selected mode.
  - ① To close the FUNCTION screen, push **EXIT**.
  - ① Touching ① or ② at the bottom of the screen selects Function screen 1 or 2.

- Push **MENU** to open the MENU screen on the selected band.
  - ① To close the MENU screen, push **EXIT**.
  - ① Touching ① or ② on the bottom of the screen selects MENU screen 1 or 2.

### FUNCTION screen list

\*1 Touch for 1 second to select the function.

\*2 Touch for 1 second to open its function menu.

P.AMP/ATT	AGC <sup>*2</sup>	NOTCH <sup>*2</sup>	NB <sup>*2</sup>
OFF	FAST	OFF	OFF
P.AMP	MID	AN	ON
ATT <sup>*1</sup>	SLOW	MN	
NR <sup>*2</sup>	IP+	VOX <sup>*2</sup>	BKIN <sup>*2</sup>
OFF	OFF	OFF	OFF
ON	ON	ON	BKIN
			F-BKIN
COMP <sup>*2</sup>	TONE <sup>*2</sup>		
OFF	OFF	DTCS	DTCS (T)/TSQ (R)
ON	TONE	DTCS (T)	TONE (T)/TSQ (R)
	TSQ (L)	TONE (T)/DTCS (R)	
D.SQ <sup>*2</sup>	TBW	1/4	MONI <sup>*2</sup>
OFF	WIDE	OFF	OFF
DSQ	MID	ON	ON
CSQ	NAR		
DUP <sup>*2</sup>	EXP P.AMP	RPS	TX PWR LIMIT <sup>*2</sup>
OFF	OFF	OFF	OFF
DUP-	ON	ON	ON
DUP+			

### ◇ QUICK MENU

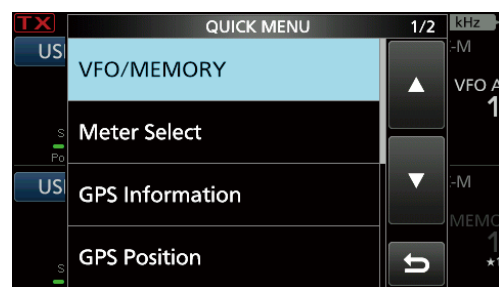

- Push **QUICK** to open the QUICK MENU screen.

◆ Multi-function menus

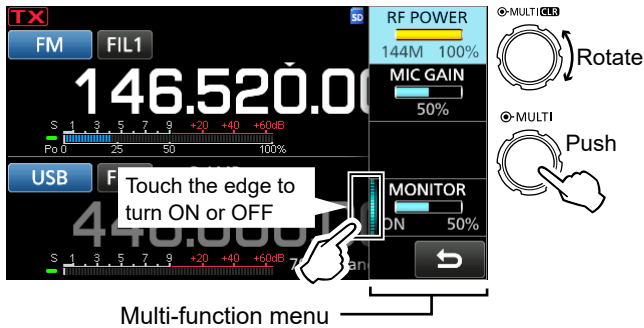

- Open the Multi-function menu by pushing **[MULTI]** (Multi-function control).
- Open special menus by holding down **[VOX/BK-IN]**, **[NB]**, **[NR]**, or **[NOTCH]** for 1 second.
- While the Multi-function menu is open, touch the desired item and rotate **[MULTI]** to set the desired value.

Multi-function menu items

- \*1 Touch the edge to turn the function ON or OFF, or when you want to adjust.
- \*2 Touch the item for 1 second to enable **[MULTI]**.
- \*3 Displayed only on the DR screen.

SSB	SSB-D	CW	RTTY
RF POWER* <sup>2</sup>	RF POWER* <sup>2</sup>	RF POWER* <sup>2</sup>	RF POWER* <sup>2</sup>
MIC GAIN* <sup>2</sup>	MIC GAIN* <sup>2</sup>	KEY SPEED* <sup>2</sup>	TPF* <sup>1</sup>
COMP* <sup>1, 2</sup>		CW PITCH* <sup>2</sup>	
MONITOR* <sup>1, 2</sup>	MONITOR* <sup>1, 2</sup>		MONITOR* <sup>1, 2</sup>
FM/AM	DV	DD	NB
RF POWER* <sup>2</sup>	RF POWER* <sup>2</sup>	RF POWER* <sup>2</sup>	LEVEL* <sup>2</sup>
MIC GAIN* <sup>2</sup>	MIC GAIN* <sup>2</sup>	TX INHIBIT* <sup>1</sup>	DEPTH* <sup>2</sup>
	RPT MONI* <sup>3</sup>		WIDTH* <sup>2</sup>
MONITOR* <sup>1, 2</sup>	MONITOR* <sup>1, 2</sup>		
NR	NOTCH	VOX	BK-IN
LEVEL* <sup>2</sup>	POSITION* <sup>2</sup>	GAIN* <sup>2</sup>	DELAY* <sup>2</sup>
	WIDTH* <sup>1</sup>	ANTI VOX* <sup>2</sup>	
		DELAY* <sup>2</sup>	
		VOICE DELAY* <sup>1</sup>	
TX PWR LIMIT			
RF POWER* <sup>2</sup>			
LIMIT			

Multi-function dial

When the Multi-function menu is closed, **[MULTI]** can be enabled to adjust functions that are either on the upper right three keys or in the Multi-function menus. The function is displayed in the upper right edge of the screen.

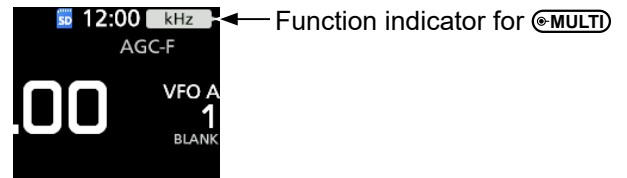

- \*1 You can independently enable **[MULTI]** to adjust the function for the MAIN and SUB bands.
- \*2 On the Multi-function menus, touch the item for 1 second to assign the function to **[MULTI]**. To cancel the function assigned to **[MULTI]**, touch the Function indicator for Multi-function control, or hold down **[MULTI]** for 1 second.

Indicator	Action	
RIT* <sup>1</sup>	Rotate	Adjusts the RIT frequency.
	Hold down	Clears the RIT frequency.
kHz* <sup>1</sup>	Changes the operating frequency on the kHz steps. ⓂRapidly rotating <b>[MULTI]</b> automatically increases the tuning speed.	
	M-CH* <sup>1</sup> Selects Memory channels. Using the DR function, selects an individual station or preset repeater.	
PBT1* <sup>1</sup>	Rotate	Adjusts the Shift value for PBT1.
	Hold down	Clears the Twin PBT setting.
PBT2* <sup>1</sup>	Rotate	Adjusts the Shift value for PBT2.
	Hold down	Clears the Twin PBT setting.
RF PWR* <sup>2</sup>	Adjusts the transmit output power.	
MIC G* <sup>2</sup>	Adjusts the microphone gain.	
COMP* <sup>2</sup>	Adjusts the Speech Compressor level.	
MONI* <sup>2</sup>	Adjusts the audio level for the Monitor function.	
SPEED* <sup>2</sup>	Sets the Key speed.	
PITCH* <sup>2</sup>	Sets the CW pitch.	
NB LEV* <sup>2</sup>	Adjusts the Noise Blanker level.	
NB DEP* <sup>2</sup>	Adjusts the DEPTH (Noise attenuation level).	
NB WID* <sup>2</sup>	Adjusts the WIDTH (Blanking duration time).	
NR LEV* <sup>2</sup>	Adjusts the Noise Reduction level.	
NOTCH* <sup>2</sup>	Adjusts the Notch frequency.	
VOX G* <sup>2</sup>	Adjusts the VOX gain.	
A-VOX* <sup>2</sup>	Adjusts the ANTI VOX level.	
VOX D* <sup>2</sup>	Adjusts the VOX delay time.	
BKIN D* <sup>2</sup>	Adjusts the Break-in delay time.	

## Keyboard entering and editing

### ◆ Entering and editing characters

You can enter and edit the items in the following table.

Menu	Category	Item	Selectable characters	Maximum characters
SET	My Station	My Call Sign (DV)/(DD)	A to Z, 0 to 9, (space), /	8+4
		TX Message (DV)	A to Z, a to z, 0 to 9, (space), _ ! " # \$ % & ' ( ) * + , - . / : ; < = > ? @ [ \ ] ^ _ ` {   } ~	20
	Network	Network Name	A to Z, a to z, 0 to 9, ! " # \$ % & ( ) + , - . ; = @ [ ] ^ _ ` { } ~	15
		Network User 1/2 ID	A to Z, a to z, 0 to 9, _ ! " # \$ % & ' ( ) * + , - . / : ; < = > ? @ [ \ ] ^ _ ` {   } ~	16
		Network User 1/2 Password	A to Z, a to z, 0 to 9, ! " # \$ % & ( ) + , - . ; = @ [ ] ^ _ ` { } ~ • Password: Minimum 8 characters	16
		Network Radio Name	A to Z, a to z, 0 to 9, (space), _ ! " # \$ % & ' ( ) * + , - . / : ; < = > ? @ [ \ ] ^ _ ` {   } ~	16
	Time Set	NTP Server Address	A to Z, a to z, 0 to 9, - .	64
SD Card	Save Setting	A to Z, a to z, 0 to 9, (space), _ ! " # \$ % & ' ( ) * + , - . / : ; < = > ? @ [ \ ] ^ _ ` {   } ~	23	
	Export	A to Z, a to z, 0 to 9, (space), _ ! " # \$ % & ' ( ) * + , - . / : ; < = > ? @ [ \ ] ^ _ ` {   } ~ • Illegal characters: / : ; * < > \		
MEMORY		Memory Name	A to Z, a to z, 0 to 9, (space), _ ! " # \$ % & ' ( ) * + , - . / : ; < = > ? @ [ \ ] ^ _ ` {   } ~	16
KEYER		Keyer Memory	A to Z, 0 to 9, (space), / ? ^ . , @ • "*" (asterisk) has its unique use.	70
DECODE		RTTY Memory	A to Z, 0 to 9, (space), ! \$ & ? " ' - / . , : ; ( ) _	70
VOICE		VOICE TX RECORD	A to Z, a to z, 0 to 9, (space), _ ! " # \$ % & ' ( ) * + , - . / : ; < = > ? @ [ \ ] ^ _ ` {   } ~	16
CS		UR, R1, R2	A to Z, 0 to 9, (space), /	8
DV/DD MEMORY	Your Call Sign	NAME	A to Z, a to z, 0 to 9, (space), _ ! " # \$ % & ' ( ) * + , - . / : ; < = > ? @ [ \ ] ^ _ ` {   } ~	16
		CALL SIGN	A to Z, 0 to 9, (space), /	8
	Repeater List	GROUP NAME, NAME	A to Z, a to z, 0 to 9, (space), _ ! " # \$ % & ' ( ) * + , - . / : ; < = > ? @ [ \ ] ^ _ ` {   } ~	16
		SUB NAME	A to Z, a to z, 0 to 9, (space), _ ! " # \$ % & ' ( ) * + , - . / : ; < = > ? @ [ \ ] ^ _ ` {   } ~	8
		CALL SIGN, GW CALL SIGN	A to Z, 0 to 9, (space), /	8
DV GW	Internal Gateway Settings	Gateway Repeater (Server IP/Domain)	A to Z, a to z, 0 to 9, - .	64
		Terminal/AP, Call Sign, Allowed Call Sign List	A to Z, 0 to 9, (space)	8
GPS	GPS TX Mode	Unproto Address	A to Z, a to z, 0 to 9, _ ! " # \$ % & ' ( ) * + , - . / : ; < = > ? @ [ \ ] ^ _ ` {   } ~ • Normally 12 characters	56
		Object Name, Item Name	A to Z, a to z, 0 to 9, _ ! " # \$ % & ' ( ) * + , - . / : ; < = > ? @ [ \ ] ^ _ ` {   } ~	9
		Comment	A to Z, a to z, 0 to 9, _ ! " # \$ % & ' ( ) * + , - . / : ; < = > ? @ [ \ ] ^ _ ` {   } ~ • Maximum characters you can enter differs, depending on the data extension and altitude settings.	43
		GPS Message	A to Z, a to z, 0 to 9, (space), _ ! " # \$ % & ' ( ) * + , - . / : ; < = > ? @ [ \ ] ^ _ ` {   } ~	20
		GPS Memory	GROUP NAME, NAME	A to Z, a to z, 0 to 9, (space), _ ! " # \$ % & ' ( ) * + , - . / : ; < = > ? @ [ \ ] ^ _ ` {   } ~
DTMF	DTMF MEMORY		0 to 9, A B C D * #	24
	SEND	Direct Input	0 to 9, A B C D * #	24
PRESET		Preset Name	A to Z, a to z, 0 to 9, (space), _ ! " # \$ % & ' ( ) * + , - . / : ; < = > ? @ [ \ ] ^ _ ` {   } ~	16
DR	TO SELECT	Direct input (UR)/(RPT)	A to Z, 0 to 9, (space), /	8
PICTURE	TX PICTURE SET	Receiver	A to Z, 0 to 9, (space)	8

◇ Keyboard types

You can select the Full Keyboard or Tenkey pad in “Keyboard Type” on the FUNCTION screen. (p. 8-6)

**MENU** » SET > Function > **Keyboard Type**

① You can also temporarily switch in the QUICK MENU by pushing **QUICK**.

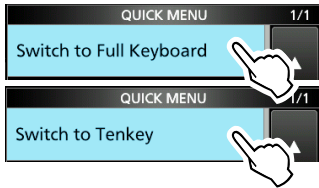

① You can select the full keyboard layout in “Full Keyboard Layout” on the FUNCTION screen. (p. 8-6)

**MENU** » SET > Function > **Full Keyboard Layout**

◇ Entering and editing

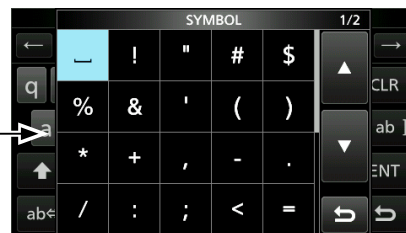
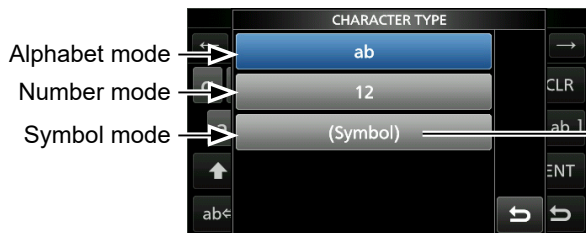
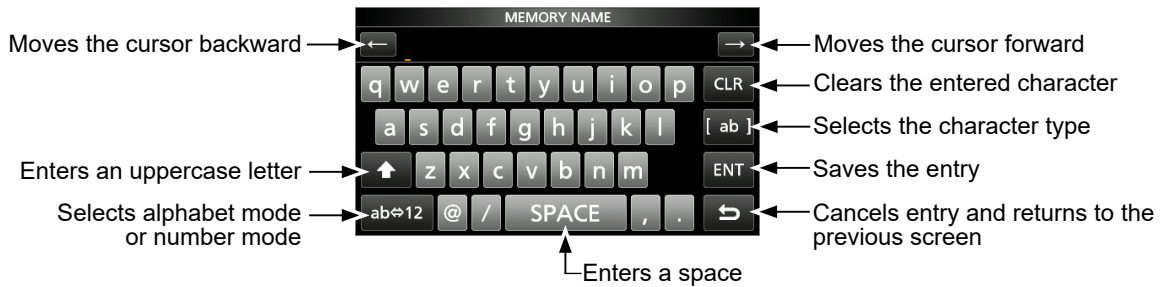

# 1 PANEL DESCRIPTION

## Keypad entering and editing (Continued)

### ◇ Entering and editing example

Entering “DX spot 1” in the Memory channel 2

1. Open the MEMORY screen.



2. Touch memory channel 2 for 1 second.

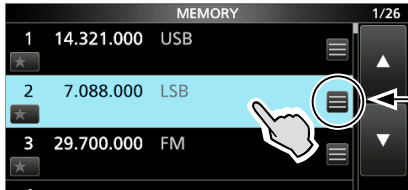

You can also open the QUICK MENU by touching this key.

- Opens the QUICK MENU.

3. Select “Edit Name.”

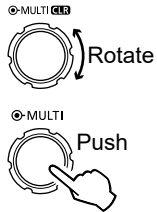
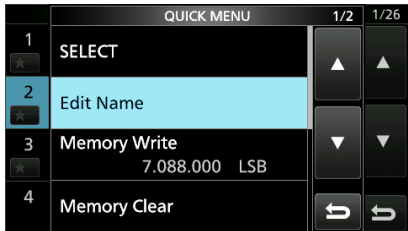

- Opens the MEMORY NAME screen.

4. Touch [1], and then touch [D].

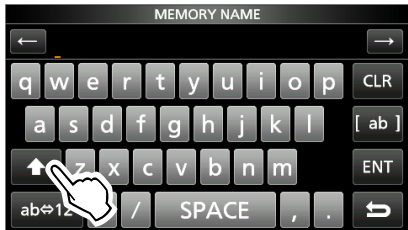

5. Touch [1] again, and then touch [X].
6. Touch [SPACE].

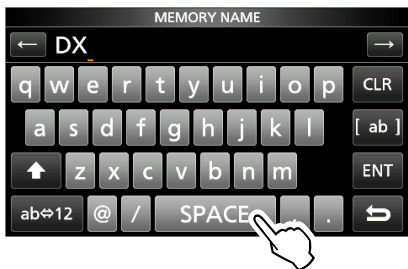

- Enters a space.

7. Touch [s], [p], [o], and then [t].
8. Touch [SPACE].

- Enters a space.

9. Touch [ab].



- Opens the entry CHARACTER TYPE screen.

10. Touch [12].

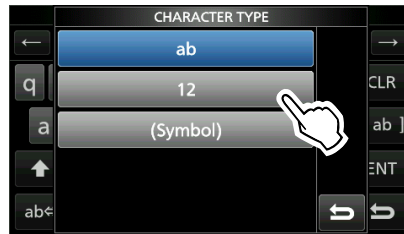

11. Touch [1].
12. Touch [ENT] to save the entry.

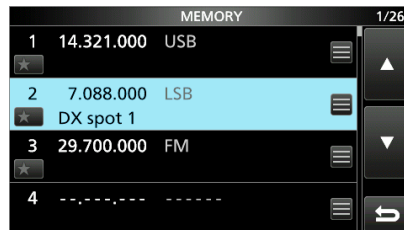
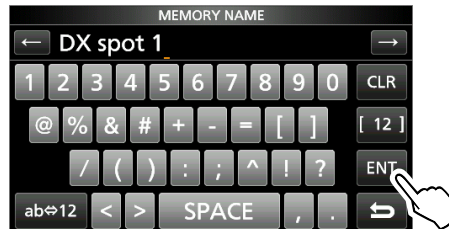

- Returns to the previous screen.

## Selecting a location

Select a location for the transceiver that allows adequate air circulation, free from extreme heat, cold or vibration, and other electromagnetic sources.

Never place the transceiver in areas such as:

- Temperatures below  $-10^{\circ}\text{C}$  ( $+14^{\circ}\text{F}$ ) or above  $+60^{\circ}\text{C}$  ( $+140^{\circ}\text{F}$ ).
- An unstable place that slopes or vibrates.
- In direct sunlight.
- High humidity and temperature environments.
- Dusty environments.
- Noisy environments.

## Using the desktop stands

The transceiver has a stand for desktop use.

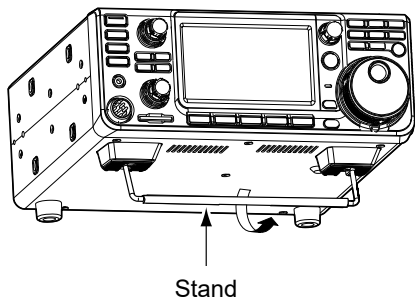

**NOTE: DO NOT** hold the stand, dials and controls when you carry the transceiver. This may damage them.

## Heat dissipation

- **DO NOT** place the transceiver against walls or put anything on top of the transceiver. This may block airflow and overheat the transceiver.
- **NEVER** install the transceiver in a place without adequate ventilation. Heat dissipation may be reduced, and the transceiver may be damaged.
- **DO NOT** touch the transceiver after transmitting continuously for long periods of time. The transceiver may become hot.

## Grounding

To prevent electric shock, television interference (TVI), broadcast interference (BCI) and other problems, ground the transceiver using the ground terminal [GND] on the rear panel.

For best results, connect a heavy gauge wire or strap to a long ground rod. Make the distance between the [GND] terminal and ground as short as possible.

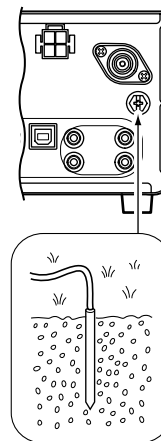

**⚠ WARNING! NEVER** connect the [GND] terminal to a gas or electric pipe, since the connection could cause an explosion or electric shock.

## Connecting an external DC power supply

Confirm that the transceiver is OFF before connecting the DC power cable.

① When connecting a non-Icom DC power cable, the transceiver needs:

- DC 13.8 V (Capacity: At least 18 Amps)
- A power supply with an over current protective line, and low voltage fluctuation or ripple.

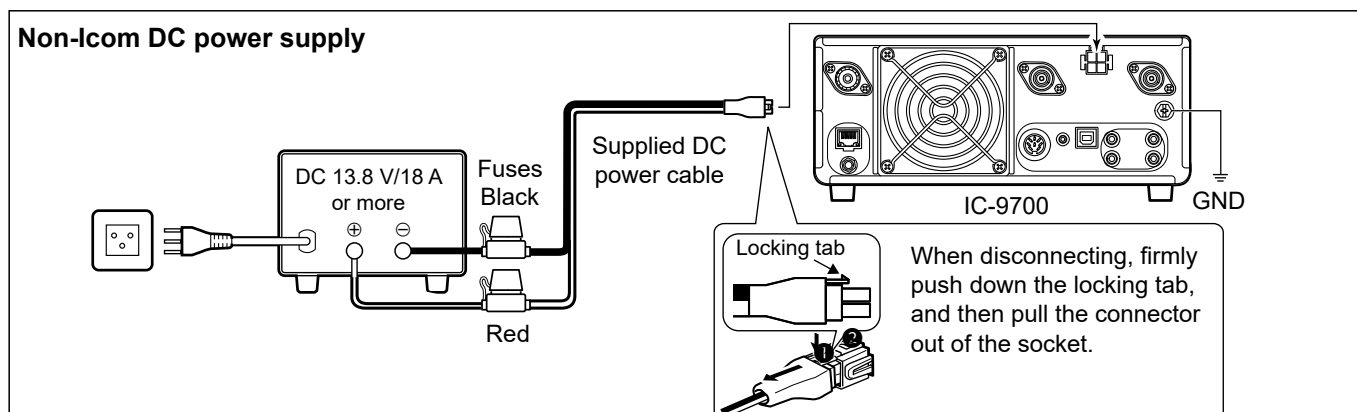

### When first applying power

Before turning ON your transceiver for the first time, make sure all connections are correctly made.

After all connections are made, set the dials to the positions described below.

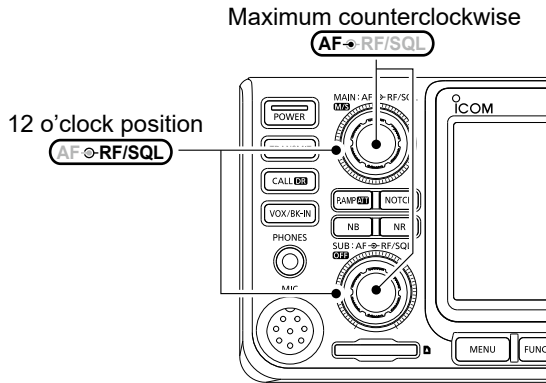

**TIP:** When you turn OFF the transceiver, it memorizes the current settings. Therefore, when you turn ON the transceiver again, it restarts with the same settings.

### Turning power ON or OFF

- To turn ON the transceiver, push **POWER**.
- To turn OFF the transceiver, hold down **POWER** for 1 second until "POWER OFF..." is displayed.

### Adjusting the volume level

Rotate **AF-RF/SQ** (inner) to adjust the volume level.

### Selecting the VFO and Memory modes

#### VFO mode

Set the desired frequency by rotating **MAIN DIAL**.

#### Memory mode

Enter contents into the desired channel in the MEMORY list.

#### Call channel mode

Call channels (or Main channel) are used to call on an often used frequency. A Call channel is assigned on each band.

#### Selecting the VFO mode or Memory mode

- Push **V/M** to select the VFO or Memory mode.
- Push **CALLDR** to select the Call channel mode.

VFO mode (Example: VFO A)

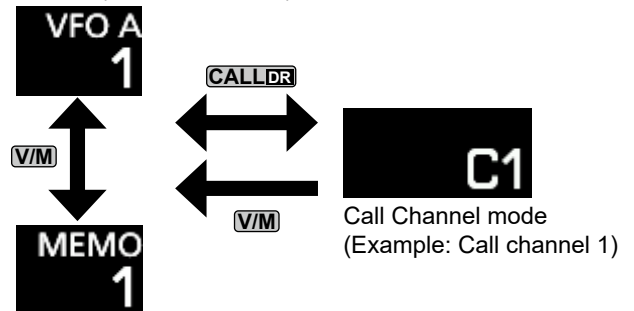

Memory mode (Example: Memory channel 1)

### Using the VFO mode

The IC-9700 has 2 Variable Frequency Oscillators (VFO), "A" and "B." Having 2 VFOs is convenient to quickly select 2 frequencies, or for split frequency operation (p. 4-9). You can use either of the VFOs to operate on a frequency and mode.

#### ◇ Selecting VFO A or VFO B

Push **A/B** to select the VFO A or VFO B.

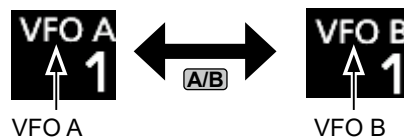

#### ◇ Equalizing VFO A and VFO B

You can set the displayed VFO's frequency to the VFO that is not displayed.

Hold down **A/B** until 2 short beeps sound.

## Dualwatch operation

Dualwatch simultaneously monitors two frequencies. The IC-9700 has 2 independent receiver circuits, the Main and Sub bands, so that you can use Dualwatch with no compromises, even on different bands and modes.

① The same frequency cannot be set to both Main and Sub bands.

Hold down **OFF** for 1 second to turn the Dualwatch function ON or OFF.

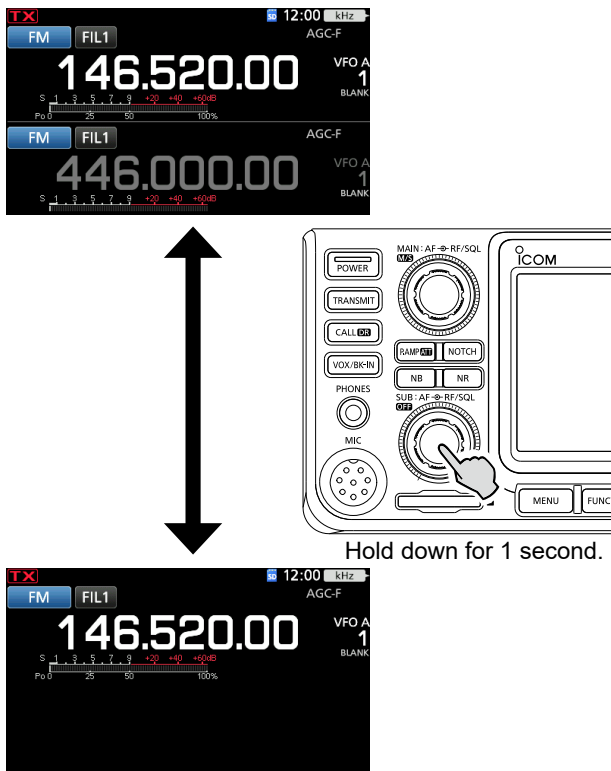

## Selecting the Main and Sub bands

The IC-9700 has 2 identical receivers, Main and Sub. The Main band is displayed on the upper half of the screen, and the Sub band is displayed on the lower half.

① Some functions can only be applied to the selected band, and you can transmit on only the Main band (except in Split Frequency operation).

To select the Main band or Sub band, touch the grayed frequency readout.

• The selected band's frequency readout is displayed clearly, and the frequency of the non-selected band is grayed.

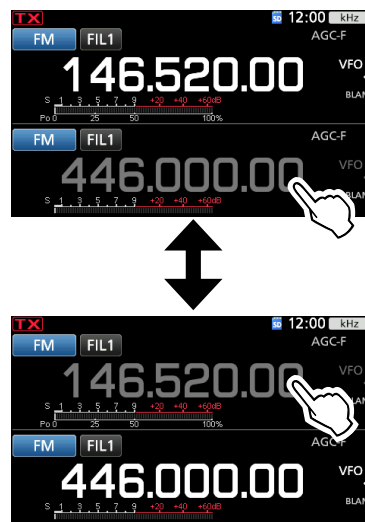

## ◇ Swapping the Main band and Sub band

Hold down **M/S** for 1 second.

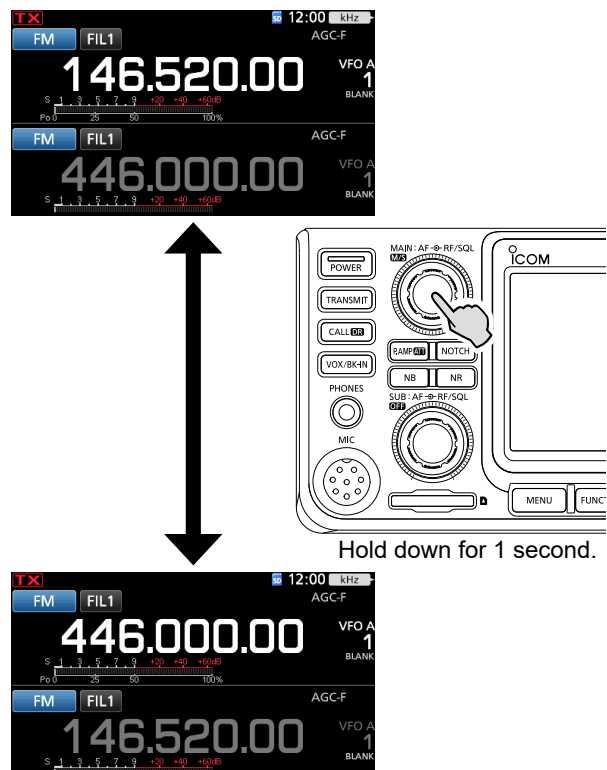

## Selecting the operating band

Do the following steps to change the operating band. Also, the band stacking register provides 3 memories for each band key to store frequencies and operating modes. This function is convenient to quickly recall previously operated frequencies and modes on the selected band.

### ◇ Using the band stacking registers

Follow the steps below to enter a register on the selected band.

1. Touch the MHz digits. (Example: 146)

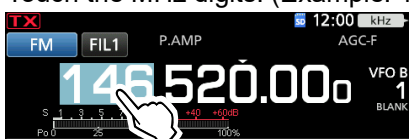

• Opens the BAND STACKING REGISTER screen.

2. Touch a band key. (Example: 1295 MHz)

① The same band cannot be set to both Main and Sub bands.

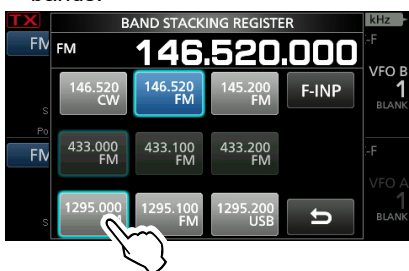

① Touch  to return to the previous screen.

## Selecting the operating mode

You can select between the SSB (LSB/USB), SSB data (LSB-DATA/USB-DATA), CW, CW reverse, RTTY, RTTY reverse, AM, AM data (AM-DATA), FM, FM data (FM-DATA), DV and DD\* modes.

\*Only for the 1200 MHz band

1. Touch the mode icon (example: FM).

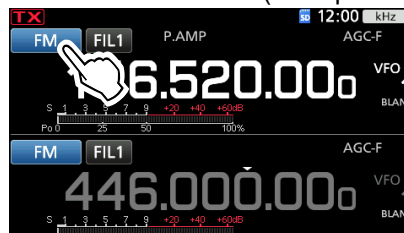

• Opens the MODE screen.

2. On the MODE screen, touch the desired mode key. (Example: SSB).

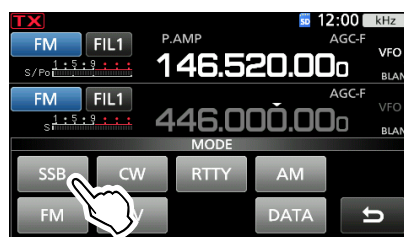

① In the SSB, AM or FM modes, the [DATA] key is displayed.

### • Operating mode selection list

① Touch mode key to select the operating mode.

Mode key	Operating mode	
[SSB]	USB	LSB
[CW]	CW	CW-R
[RTTY]	RTTY	RTTY-R
[AM]	AM	
[FM]	FM	
[DV]	DV	
[DD]	DD	
[DATA]	LSB	LSB-D
	USB	USB-D
	AM	AM-D
	FM	FM-D

### Selecting the Data mode

You can operate data communications (SSTV, RTTY (AFSK), PSK31, JT65B and FT8).

① When a data mode is selected, you can mute the input from the microphone.

**MENU** » **SET > Connectors > MOD Input > DATA MOD**

① In the PRESET menu, you can save the combination of the settings for the data mode to quickly change the settings, depending on your operating needs. See the Advanced Manual for details.

# Setting the frequency

## ◇ Using the Main Dial

1. Select the desired operating band. (p. 3-3)  
(Example: 145 MHz)
2. Rotate **(MAIN DIAL)**.
  - The frequency changes according to the selected Tuning Step.
  - ① **TX** is displayed when you set an amateur radio frequency, and **TX** (with dotted line) is displayed when you set a frequency outside the Ham band, or outside your set Band Edges.

## ◇ About the Tuning Step function

You can set the **(MAIN DIAL)**'s tuning step for each operating mode.  
Touch the kHz digits to turn the Tuning Step function ON or OFF.

- ① The Tuning Step function's icon "▼" is displayed above the 1 kHz digit.

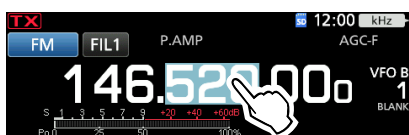

## ◇ Changing the Tuning Step

When the Tuning Step function is ON, you can change the tuning steps for each operating mode.

1. Select the desired operating mode. (p. 3-3)  
(Example: FM)
2. Touch the kHz digit for 1 second.

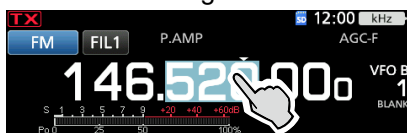

3. Touch the desired tuning step. (Example: 0.1 k)

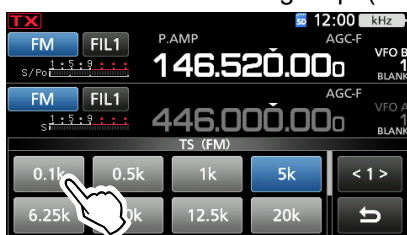

- The tuning step is set and returns to the previous screen.

## ◇ About the 1 MHz Step Tuning function

You can use the maximum tuning step of 1 MHz.

Touch the MHz digits for 1 second to turn the MHz Step Tuning function ON or OFF.

- ① When using the [UP]/[DN] keys on the microphone, the frequency changes in 1 MHz steps.

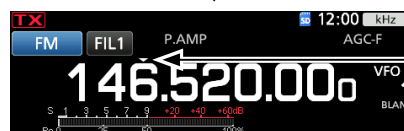
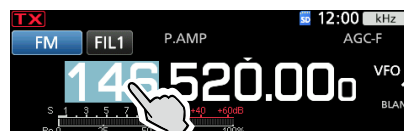

## ◇ About the 1 Hz step Fine Tuning function

You can use the minimum tuning step of 1 Hz for fine tuning in the SSB, CW and RTTY modes.

Touch the Hz digits for 1 second to turn the Fine Tuning function ON or OFF.

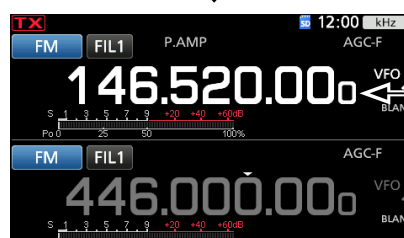
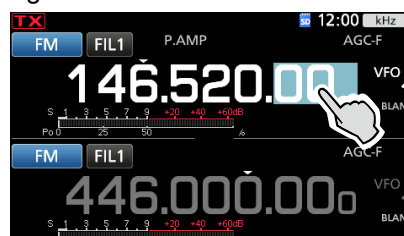

- ① When using the [UP]/[DN] keys on the microphone, the frequency changes in 50 Hz steps with the Fine Tuning function ON or OFF.

## Setting the frequency (Continued)

### ◇ About the 1/4 Tuning function

**Mode: SSB-D/CW/RTTY**

With the Tuning Function OFF, turn ON the 1/4 Tuning function to reduce the tuning speed to 1/4 of the normal speed, for finer tuning.

1. Push **FUNCTION**.  
• Opens the FUNCTION screen.
2. Touch [1/4].

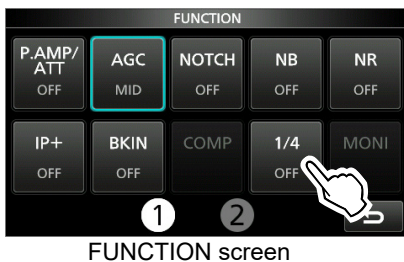

3. Push **EXIT**.



### ◇ About the Auto Tuning Step function

The tuning step automatically changes, depending on the rotating speed of **MAIN DIAL**.

① You can change the Auto Tuning Step function settings in the following menu. (p. 8-5)

**MENU** » **SET > Function > MAIN DIAL Auto TS**

### ◇ Directly entering a frequency

You can set the frequency without rotating **MAIN DIAL** by directly entering it on the keypad.

#### Entering the operating frequency

1. Touch the MHz digits. (Example: 146)



• Opens the BAND STACKING REGISTER screen.

2. Touch [F-INP].



• Opens the F-INP screen.

3. Start entry with the most significant digit.



① To clear the entry, touch [CE].

① To clear the entry and return to the previous screen, push **EXIT**.

4. Touch [ENT] to set the entered frequency.

• Closes the F-INP screen.

① If you touch [ENT] when the digits under 100 kHz are not entered, "0" will be automatically entered into the digits that are blank.

#### Entry examples

- 144.680 MHz: [1], [4], [4], [•(-)], [6], [8], [0], [ENT]
- 145.000 MHz: [1], [4], [5], [ENT]
- Changing from 144.680 MHz to 144.540 MHz:  
[•(-)], [5], [4], [0], [ENT]

Setting the frequency (Continued)

Entering the Split Frequency Offset

1. Touch the MHz digits. (Example: 146)



- Opens the BAND STACKING REGISTER screen.

2. Touch [F-INP].

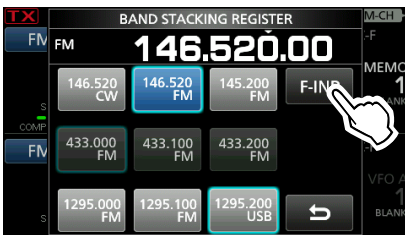

- Opens the F-INP screen.



[SPLIT] or [-SPLIT] is displayed

3. Enter the Split Frequency Offset.
  - ① If you want the minus shift direction, touch [\*(-)].
  - ① Enter the offset between -9.999 MHz and +9.999 MHz (1 kHz steps).
  - ① To clear the entry, touch [CE].
  - ① To clear the entry and return to the previous screen, push [EXIT].
  - ① After entering, the Split function is automatically turned ON.
4. To save the entry, touch [SPLIT] or [-SPLIT].
  - Closes the F-INP screen.

Entry examples

- 5 kHz: [5], [SPLIT]
- -10 kHz: [\*(-)], [1], [0], [-SPLIT]

NOTE:

If the entered operating frequency is out of an amateur band's frequency range, the transmit frequency is automatically set to the band edge frequency.

Selecting a Memory channel by number

1. Touch [V/M] to select the Memory mode.
2. Touch the MHz digits. (Example: 146)



- Opens the BAND STACKING REGISTER screen.

3. Touch [F-INP].



- Opens the F-INP screen.

4. Enter a Memory channel number. (Example: 10)



- ① If you want to set the Program Scan Edge channel or Call channel, enter between "100" ~ "107."

Channel type	Channel number	Number to enter
Programming Scan Edge	1A	100
	1B	101
	2A	102
	2B	103
	3A	104
Call channel	3B	105
	C1	106
	C2	107

5. Touch [MEMO] to select the memory channel of entered number.
  - Closes the F-INP screen.
  - The selected memory channel contents are displayed.

◇ Band Edge Beep

You will hear a Band Edge Beep and **TX** will be displayed when you tune into or out of an amateur band's frequency range.

① You can change the Band Edge Beep settings in the following menu.

[MENU] » [SET > Function > Band Edge Beep]

① If the Beep Level item is set to "0%," no beep sounds.

[MENU] » [SET > Function > Beep Level]

## Setting the frequency (Continued)

### ◇ Entering a Band Edge

When “ON (User)” or “ON (User) & TX Limit” is selected on the “Band Edge Beep” screen, you can enter a total of 30 band edge frequency pairs.

①Initially, all Ham band frequencies are entered into the first 3 band edges. Therefore, you must first edit or delete them to enter a new band edge.

①You cannot enter an overlapping frequency, or a frequency that is out of the preset Ham band frequencies.

①Band edges are entered from the lower frequency first.

1. Open the “Band Edge Beep” screen.

**MENU** » **SET > Function > Band Edge Beep**

2. Select “ON (User)” or “ON (User) & TX Limit.”  
 ①If you select “ON (User) & TX Limit,” you can limit transmission to within the entered frequency range.

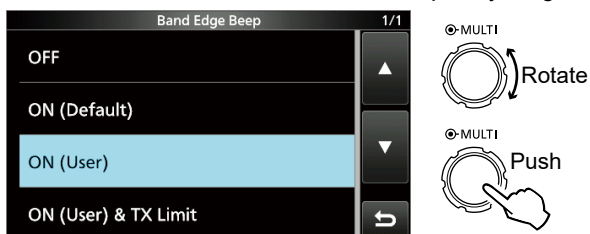

3. Select “User Band Edge.”

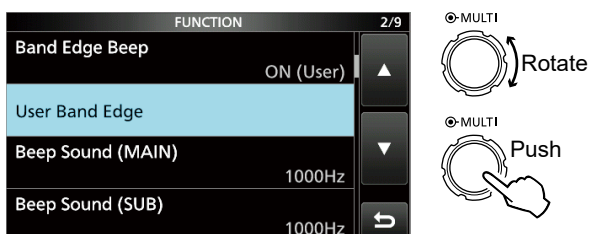

• Opens the “User Band Edge” screen.

### Editing a Band Edge

You can edit a band edge entered as a default or when entering a new band edge.

1. On the FUNCTION set screen, select “User Band Edge.”
2. Touch the band edge you want to edit.  
 (Example: 2: 430.000.000 – 440.000.000 MHz)

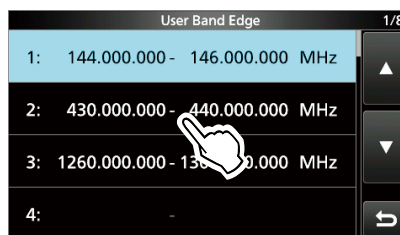

3. Edit the lower band edge frequency, then touch [ENT].  
 (Example: 430.1)

Entry example: [·], [1], [ENT]

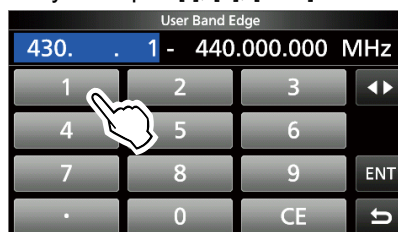

4. Edit the upper band edge frequency, then touch [ENT]. (Example: 439.1)

Entry example: [4] [3] [9] [·], [9], [ENT]



• The edited band edge is saved and returns to the previous screen.

**TIP:**  
 You can also edit the frequency by rotating **MAIN DIAL** or **MULTI**.

Setting the frequency

**Deleting a Band Edge**

To enter a new band edge, first you must delete a preset band edge.

1. On the FUNCTION set screen, select “User Band Edge.”
2. Touch the desired band edge to delete for 1 second.  
(Example: 3: 1260.000.000 – 1300.000.000 MHz)

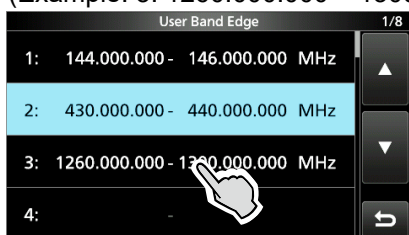

3. Touch “Delete.”

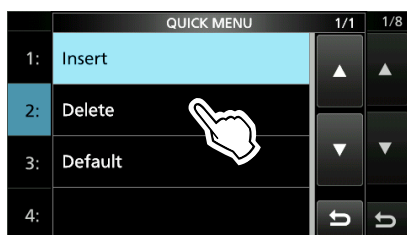

- The selected band edge is deleted and returns to the previous screen.

**Entering a new Band Edge**

After you delete or edit the preset band edges, you can enter a new band edge.

1. On the FUNCTION set screen, select “User Band Edge.”
2. Touch a blank band. (Example: 5)

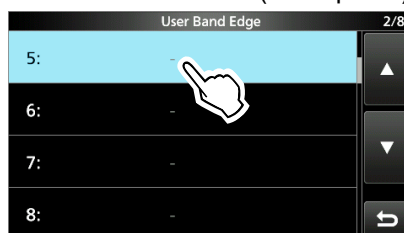

3. Enter the lower band edge frequency, then touch [ENT]. (Example: 430.1)  
Entry example: [4] [3] [0] [.] [1] [ENT]

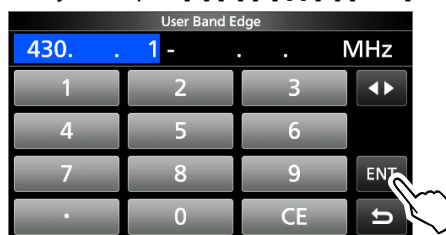

4. Enter the upper band edge frequency, then touch [ENT]. (Example: 439.9)  
Entry example: [4] [3] [9] [.] [9] [ENT]

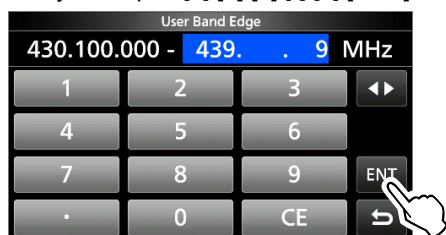

- The entered band edge is saved and returns to the previous screen.

### 3 BASIC OPERATION

#### Setting the frequency

##### ◇ Entering a Band Edge (Continued)

##### Inserting a Band Edge

After you delete or edit the preset band edges, follow the steps below to insert a band edge.

1. On the FUNCTION set screen, select “User Band Edge.”
2. Touch the band edge you want to insert a new band edge above for 1 second.  
(Example: 3: 1261.000.000–1300.000.000 MHz)

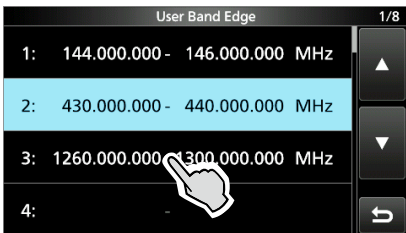

① The new band edge will be inserted above the selected band edge.

3. Touch “Insert.”



4. Enter the lower band edge frequency then touch [ENT]. (Example: 430.1)  
Entry example: [4] [3] [0] [\*] [1] [ENT]

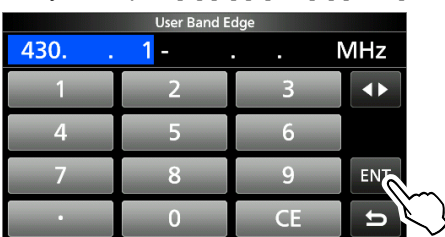

5. Enter the upper band edge frequency, then touch [ENT]. (Example: 439.9)  
Entry example: [4] [3] [9] [\*] [9] [ENT]

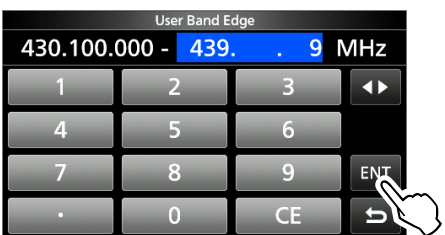

• The entered band edge is saved and returns to the previous screen.

##### Resetting all band edges to presets

The steps below will reset all the band edges to their initial settings. All entered settings will be deleted.

1. Open the “User Band Edge” screen.
2. Touch any band edge for 1 second.

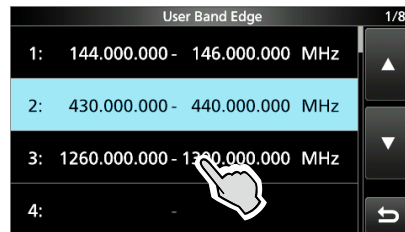

3. Touch “Default.”



• Displays “Reset All Edges?”

4. Touch [YES].

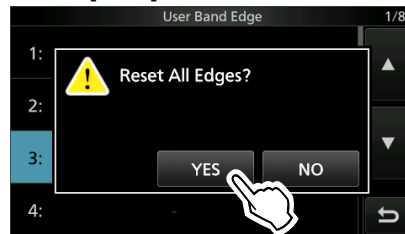

• All the band edges reset to the initial settings.

## RF gain and SQL level

Rotate **(AF/RF/SQL)**(outer) to adjust the RF gain and SQL level.

By default, rotating left (when set to the 12 o'clock position) adjusts the RF gain, and rotating right adjusts the squelch level, as described below.

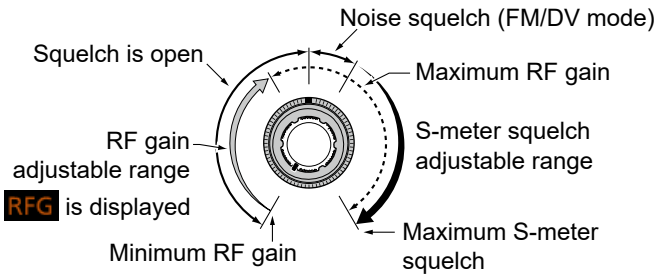

### RF gain

Adjust the RF gain to decrease the noise received from a nearby strong station.

- Rotate counterclockwise to reduce the RF gain, which reduces the receive sensitivity. "RFG" appears when **(AF/RF/SQL)** is set to the counterclockwise from the 11 o'clock position. "RFG" indicates that the RF gain is reduced.
  - ① If a strong signal is received and "OVF" (Overflow) appears, reduce the RF gain until "OVF" disappears.

### SQL level

There are 2 types of SQL levels, depending on the operating mode.

#### • Noise squelch

Rotate the **(AF/RF/SQL)**(outer) until the noise just disappears and the TX/RX indicator goes OFF.

#### • S-meter squelch

The S-meter squelch disables the audio output from the speaker or headphones when the received signal is weaker than the specified S-meter squelch level.

Rotate the **(AF/RF/SQL)** clockwise from the 12 o'clock position to increase the S-meter threshold level.

- ① You can change the **(AF/RF/SQL)**(outer) control type in "RF/SQL Control." (p. 8-3)

**MENU** » **SET > Function > RF/SQL Control**

## Dial Lock function

The Dial Lock function prevents frequency changes caused by accidentally moving **(MAIN DIAL)**.

- ① This function electronically locks the dial.

Hold down **(SPEECH)** for 1 second to turn the Dial Lock function ON or OFF.

- You can select the Dial lock or Panel lock. (p. 8-5)

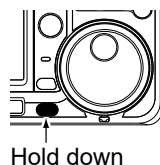

**MENU** » **SET > Function > Lock Function**

## Adjusting the transmit output power

Before transmitting, monitor your selected operating frequency to make sure you do not cause interference to other stations on the same frequency. It is good amateur practice to listen first, and then, even if nothing is heard, ask if the frequency in use once or twice, before you start operating.

### ◇ Adjusting the transmit output power

1. Select the operating mode. (p. 3-3) (Example: USB)
2. Touch the meter to display the Po meter. (p. 3-11)

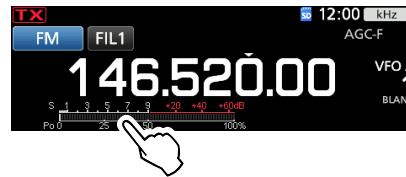

3. Open the Multi-function menu.



4. Push **(TRANSMIT)** or hold down [PTT].
  - The Po meter level changes according to your voice level in the SSB mode.
  - The TX/RX indicator lights red and **TX** is displayed.
5. Touch "RF POWER."
6. Adjust the transmit output power to between 0 and 100%.
  - The Po meter displays the RF output power in a percentage. It becomes the S-meter while receiving.
7. Push **(TRANSMIT)** or release [PTT].
  - Returns to receive.

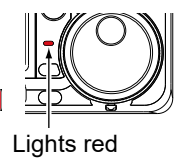

## Transmit Power Limit function

The Transmit Power Limit function limits the output power to the preset level for each band.

1. On the FUNCTION set screen, touch [TX PWR LIMIT].
  - Each touch turns the function ON or OFF.
2. Touch [TX PWR LIMIT] for 1 second.
3. Rotate **(MULTI)** to set the maximum transmit power.

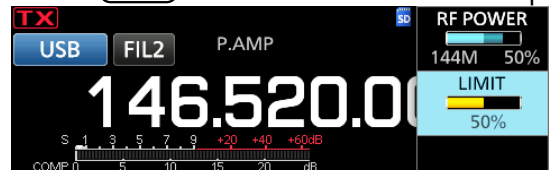

4. Push **(MULTI)** to close the MENU.

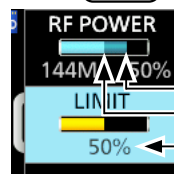

- Set transmit power
- Limited transmit power (LIMIT value)
- Even when set RF POWER exceeds "LIMIT," the actual output power is limited to this value.

## Meter display

### ◇ Meter display selection

You can display one of the 6 different transmit parameters (Po, SWR, ALC, COMP, VD and ID) for your convenience.

Touch the parameter to display one of the meters.



### ◇ Multi-function meter

You can display all the parameters simultaneously.

① The TEMP meter is also displayed on the Multi-function meter.

Touch the parameter for 1 second to display the Multi-function meter.

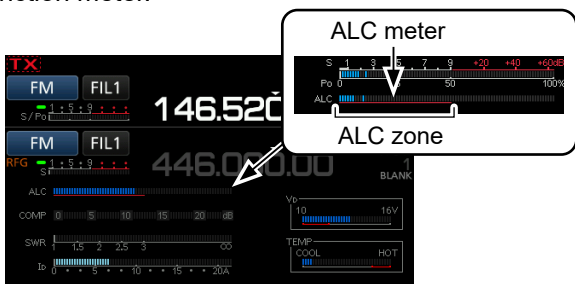

Multi-function meter

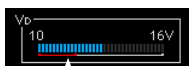

When the VD meter reads on the red under line or below, the output power may decrease or transceiver power may be shut down.



Displays the temperature of the final amplifier MOS-FETs.

- S:** Displays the receiving signal strength level.
- Po:** Displays the relative RF output power.
- SWR:** Displays the SWR of the antenna at the frequency.
- ALC:** Displays the ALC level. When the meter movement shows the input signal level exceeds the allowed level, the ALC limits the RF power. In such cases, decrease the microphone gain level.
- COMP:** Displays the compression level when the speech compressor is used.
- VD:** Displays the drain voltage of the final amplifier MOS-FETs.
- ID:** Displays the drain current of the final amplifier MOS-FETs.
- TEMP:** Displays the temperature of the final amplifier MOS-FETs.

## Adjusting the microphone gain

Adjust the microphone gain as described below.

1. Set the operating band and mode to SSB, AM, FM or DV. (p. 3-3)
2. Push **[MULTI]** to display the Multi-function menu.
3. Push **[TRANSMIT]** or hold down **[PTT]**.
4. Touch "MIC GAIN," and rotate **[MULTI]** to adjust the microphone gain.

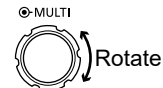

① Setting "50%" can be used for most voice operations, but do following to make sure the microphone gain is properly set.

- Hold the microphone 5 to 10 cm (2 to 4 inches) from your mouth, then hold down **[PTT]** on the microphone and speak at your normal voice level.
  - In the SSB mode, touch the TX meter to select the ALC meter, and rotate **[MULTI]** to adjust the microphone gain until the meter reading swings between 30 to 50% of the ALC scale.
  - In the AM, FM or DV mode, check the audio clarity with another station, or use the Monitor function (p. 4-7).
5. Push **[TRANSMIT]** or release **[PTT]**.
    - Returns to receive.

## Preamplifiers

The preamp amplifies received signals in the receiver front end to improve the signal-to-noise ratio and sensitivity. A preamp is used when receiving weak signals.

① Each band memorizes the Preamplifier setting.

Push **P.AMP** (P.AMP).

① Each push turns the preamplifier ON or OFF.

Displayed when the preamp is used.



**NOTE:** When you use the preamp while receiving strong signals, the receiving signal may be distorted. In such case, turn OFF the preamp.

### Using an external preamp

You can also use an external preamp (User supplied)

① To use an external preamp, you need to set the External Preamplifier ON or OFF for each band on the MENU screen.

**MENU** » **SET > Connectors > External P.AMP**

1. Push **FUNCTION**.
2. Touch **[2]** to change the screen.
3. Touch **[EXT P.AMP]**.

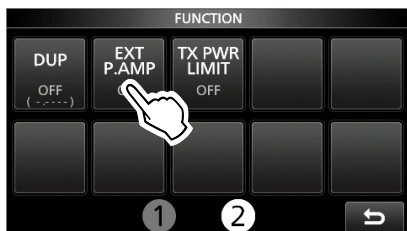

• Each push turns the external preamp ON or OFF.

## Attenuator

The Attenuator prevents a desired signal from becoming distorted when a very strong signal is near the frequency, or when a very strong electric field, such as from a broadcasting station, is near your location.

① Each band memorizes the Attenuator setting.

Hold down **P.AMP** (ATT) for 1 second to turn ON the Attenuator.

① Pushing **P.AMP** turns OFF the Attenuator (no icon).

① If a strong signal is received and "OVF" (Overflow) appears, turn ON the attenuator, or reduce the RF gain until "OVF" disappears. (p. 3-10)

Displayed when the Attenuator is ON



## RIT function

The RIT (Receive Increment Tuning) function compensates for differences in frequencies of other stations.

The function shifts the receive frequency up to  $\pm 9.9$  kHz without shifting the transmit frequency.

1. Push **RIT**.

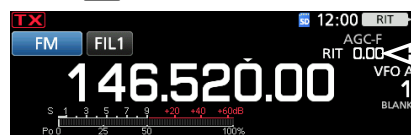

RIT frequency (3 digits)

• The RIT function turns ON.

① While using the Fine Tuning function (p. 3-4), the RIT frequency is displayed in 4 digits, instead of 3.

① Pushing **RIT** again turns OFF the RIT function.

2. Set the RIT frequency to match the received station's frequency.



Set the RIT frequency.



① You can reset the RIT frequency to "0.00" by holding down **(MULT)** for 1 second.

① You can add the frequency shift to the operating frequency by holding down **RIT** for 1 second.

3. After communicating, push **RIT** to turn the RIT function OFF.

### ◇ RIT monitor function

When the RIT function is ON, you can directly monitor the operating frequency by holding down **XFC**.

① While monitoring, the RIT function is temporarily OFF.

① While monitoring, the settings for the Noise Reduction, Notch filter and Twin PBT are temporarily OFF.

## CW Auto Tuning function

### CW mode

You can tune in a CW signal you are receiving using the Auto Tuning function. You can automatically tune by pushing **(AUTO TUNE)**. This function is active in only the CW mode.

① During the Dual Watch mode, this function works on the selected operational band (Main/Sub).

① While using RIT, the RIT frequency is automatically tuned by this function.

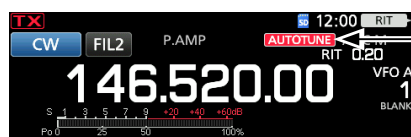

Displayed while tuning

**NOTE:** When receiving a weak signal, or receiving a signal with interference, the Auto Tuning function may tune the receiver to an undesired signal, or may not start to tune. In such case, a warning beep sounds.

① The Auto Tuning function tunes the frequency in the IF bandwidth.

## AGC function control

### SSB, CW, RTTY and AM modes

The AGC (Automatic Gain Control) controls receiver gain to produce a constant audio output level, even when the received signal strength greatly varies.

①Each band memorizes the AGC setting.

### ◇ Selecting the AGC time constant preset value

The transceiver has FAST, MID and SLOW preset AGC settings for all modes, except for the FM, DV and DD modes.

1. Select the operating mode.  
(Example: SSB)
2. Push **FUNCTION**.  
• Opens the FUNCTION screen.
3. Touch [AGC] to select the desired time constant.



- ① Touching [AGC] selects FAST, MID or SLOW.
- ① For FM, DV and DD modes, FAST is fixed.

4. To close the FUNCTION screen, push **EXIT**.

**NOTE:** While you are receiving weak signals, and a strong signal is momentarily received, the AGC function quickly reduces the receiver gain. When that signal disappears, the transceiver may not receive the weak signal because of the AGC action. In that case, select FAST, or touch [AGC] for 1 second to open the AGC screen, and then select OFF.

### ◇ Setting the AGC time constant

You can set the preset AGC time constant to the desired value.

1. Select the operating mode.  
(Example: SSB)
2. Push **FUNCTION**.  
• Opens the FUNCTION screen.
3. Touch [AGC] for 1 second.

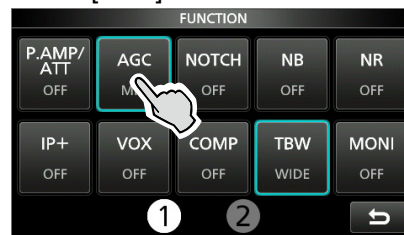

• Opens the AGC (SSB) screen.

4. Touch FAST, MID or SLOW.  
(Example: MID)



You can reset to the default settings by touching this key for 1 second.

5. Rotate **MAIN DIAL** to set the time constant.
6. To close the AGC (SSB) screen, push **EXIT**.

### • Selectable AGC Time constant (unit: seconds)

Mode	Default	Adjustable time constant
LSB USB	0.3 (FAST)	OFF, 0.1, 0.2, 0.3, 0.5, 0.8, 1.2, 1.6, 2.0, 2.5, 3.0, 4.0, 5.0 or 6.0
	2.0 (MID)	
	6.0 (SLOW)	
CW/RTTY	0.1 (FAST)	OFF, 0.1, 0.2, 0.3, 0.5, 0.8, 1.2, 1.6, 2.0, 2.5, 3.0, 4.0, 5.0 or 6.0
	0.5 (MID)	
	1.2 (SLOW)	
AM	3.0 (FAST)	OFF, 0.3, 0.5, 0.8, 1.2, 1.6, 2.0, 2.5, 3.0, 4.0, 5.0, 6.0, 7.0 or 8.0
	5.0 (MID)	
	7.0 (SLOW)	
FM	0.1 (FAST)	Fixed
DV	0.1 (FAST)	Fixed
DD	0.1 (FAST)	Fixed

## Using the Digital Twin PBT

### SSB, CW, RTTY and AM modes

To reject interference, the Digital Twin PBT (Passband Tuning) narrows the IF passband width by electronically shifting the IF frequency to slightly above or below the IF center frequency. The IC-9700 uses the digital function using the FPGA (Field Programmable Gate Array) filtering method.

① Each band memorizes the PBT setting.

1. Push [PBT] to select "PBT1."

① Each push selects "PBT1" or "PBT2."



2. Rotate [MULTI] to adjust the shift value.

① The passband width and shift value are displayed.



① Hold down [MULTI] for 1 second to clear the PBT setting.

3. Repeat steps 1 and 2 to adjust the shift value for "PBT2."

### ① Information

- To narrow the IF passband width, shift "PBT1" and "PBT2" to the opposite direction from each other, to narrow the overwrapped area.
- To shift the IF left or right, set "PBT1" and "PBT2" to the same value.
- The PBT is adjustable in 50 Hz steps in the SSB, CW, and RTTY modes, and 200 Hz in the AM mode. In this case, the center shift value changes in 25 Hz steps in the SSB, CW, and RTTY modes, and 100 Hz in the AM mode.

**NOTE:** While rotating [MULTI], you may hear some noise. This comes from the FPGA and does not indicate an equipment malfunction.

### ① Information

- A dot "." is displayed on the IF Filter Indicator when you change the IF passband width, using the Digital Twin PBT.

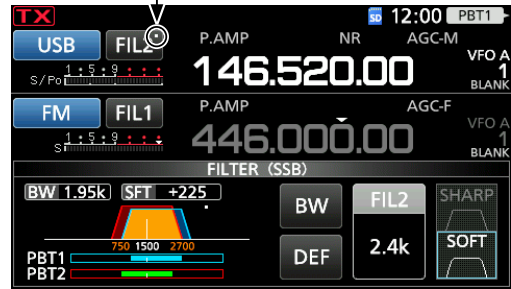

- Touch the filter icon for 1 second to display the current passband width and shift value. Opens the FILTER screen.

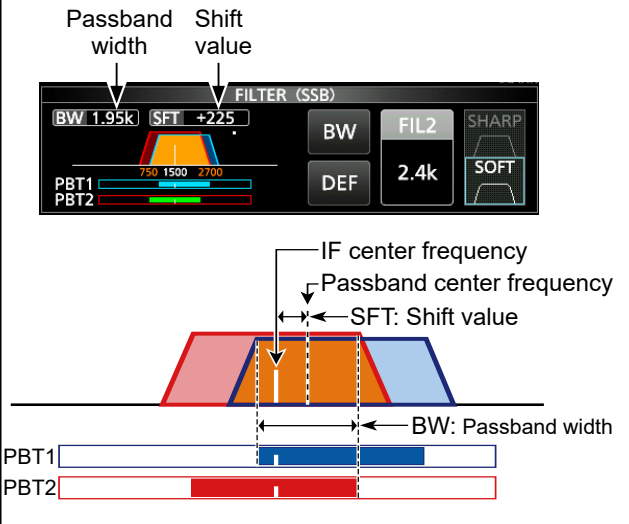

PBT is OFF



IF center frequency

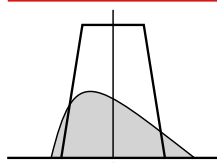

Cutting lower passband



Interference  
Desired signal

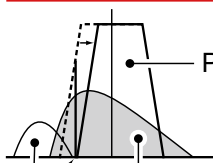

Cutting both higher and lower passbands



Interference  
Desired signal  
Interference

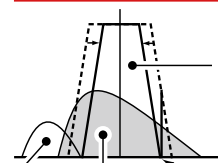

## Selecting the IF filter

### SSB, CW, RTTY and AM modes

The IC-9700 has 3 IF filter passband widths for each mode, and you can select them on the FILTER screen. You can set the IF filter to wide (FIL 1), mid (FIL 2) or narrow (FIL 3).

1. Select the operating mode. (Example: USB)
2. Touch the filter icon for 1 second.

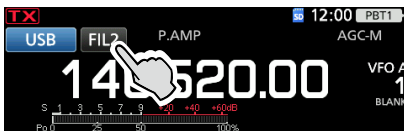

- Opens the FILTER (SSB) screen.
3. Touch the filter icon several times to select FIL 1 (wide), FIL 2 (mid) or FIL 3 (narrow).
  4. Touch [BW].
  - Selects the passband width mode.
  5. Rotate **(MAIN DIAL)** to select the passband width.

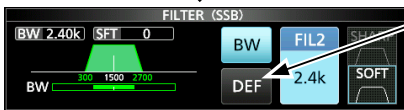

Touch for 1 second to reset to default.

- ① You cannot change the passband width in the FM, FM-D, DV or DD mode.
  - ① When you change the passband width, the Digital Twin PBT setting value is reset to the center position.
  - ① "BPF" is displayed when a band width less than 500 Hz is selected in the SSB, CW or RTTY mode.
6. To close the FILTER screen, push **(EXIT)**.

Mode	IF filter	Selectable range (steps)
SSB	FIL 1 (3.0 kHz)	50 Hz to 500 Hz (50 Hz)/ 600 Hz to 3.6 kHz (100 Hz)
	FIL 2 (2.4 kHz)	
	FIL 3 (1.8 kHz)	
SSB-D	FIL 1 (3.0 kHz)	50 Hz to 500 Hz (50 Hz)/ 600 Hz to 3.6 kHz (100 Hz)
	FIL 2 (1.2 kHz)	
	FIL 3 (500 Hz)	
CW	FIL 1 (1.2 kHz)	50 Hz to 500 Hz (50 Hz)/ 600 Hz to 3.6 kHz (100 Hz)
	FIL 2 (500 Hz)	
	FIL 3 (250 Hz)	
RTTY	FIL 1 (2.4 kHz)	50 Hz to 500 Hz (50 Hz) 600 Hz to 2.7 kHz (100 Hz)
	FIL 2 (500 Hz)	
	FIL 3 (250 Hz)	
AM AM-D	FIL 1 (9.0 kHz)	200 Hz to 10.0 kHz (200 Hz)
	FIL 2 (6.0 kHz)	
	FIL 3 (3.0 kHz)	
FM FM-D	FIL 1 (15 kHz)	Fixed
	FIL 2 (10 kHz)	
	FIL 3 (7.0 kHz)	
DV	FIL 1 (15 kHz)	Fixed
	FIL 2 (10 kHz)	
	FIL 3 (7.0 kHz)	
DD	FIL 1 (150 kHz)	Fixed

**TIP:** When you set the IF filter to FIL2 or FIL3 in the FM mode, the transceiver will transmit in the FM narrow mode.

## Selecting the IF filter shape

### SSB and CW modes

You can set the IF filter shape for each operating mode.

1. Select the operating mode. (Example: USB)
2. Touch the filter icon for 1 second.

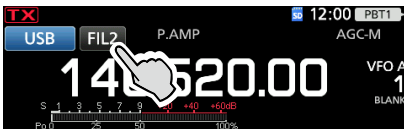

- Opens the FILTER screen.
3. Touch the filter icon several times to select FIL1 (wide), FIL2 (mid) or FIL3 (narrow).

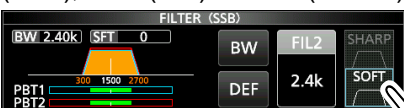

When [SOFT] is selected

4. Touch [SHARP] or [SOFT].
5. To close the FILTER screen, push **(EXIT)**.

### • SHARP

This selection is to emphasize the passband width of the filter. The filter has an almost ideal shape factor. Signals that are out of the passband are extremely filtered out, and it gives you better audio quality.

### • SOFT

The filter shoulders are roundly formed as in analog filters. This decreases noise components in the high and low frequencies of the filter passband, and increases the S/N of the target signal. These characteristics play an effective role in picking up very weak signals in the 50 MHz band, for example. The shape factor is kept, and the sharpness of the bandpass is excellent.

# Noise Blanker

## SSB, CW, RTTY and AM modes

The Noise blanker eliminates pulse-type noise such as the noise from car ignitions.

Push **[NB]** to turn the Noise Blanker ON or OFF.



**NOTE:** When using the Noise Blanker, received signals may be distorted if they are excessively strong, or the noise is other than a pulse type. In that case, turn OFF the Noise Blanker, or shallow the DEPTH on the NB menu. See the description below for details.

### ◇ Adjusting the NB level and time

To deal with various types of noise, you can adjust the attenuation level and blanking depth and width in the NB menu.

1. Hold down **[NB]** for 1 second.  
• Turns ON the Noise Blanker and opens the NB menu.
2. Touch the item to adjust. (Example: DEPTH)

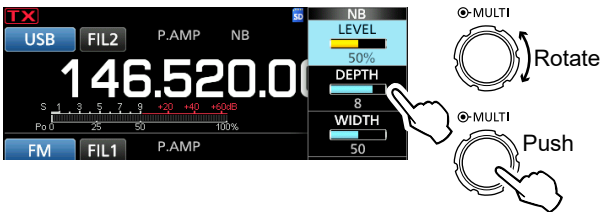

3. Rotate **[MULTI]** to adjust the item. (Example: 8)
4. Push **[MULTI]** to close the NB menu.

### NB is OFF

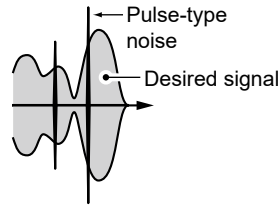

### NB is ON (Effective)

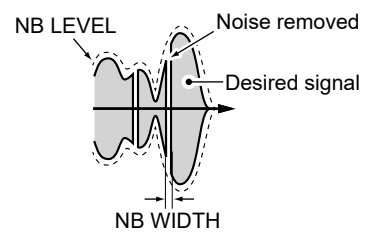

### NB is ON (DEPTH is too short)

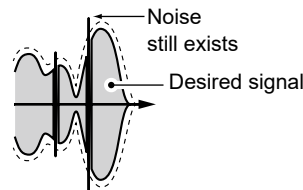

### NB is ON (WIDTH is too wide)

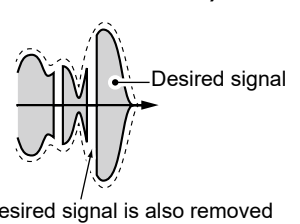

### LEVEL (Default: 50%)

Adjust the level where the Noise Blanker activates between 0 and 100%.

### DEPTH (Default: 8)

Adjust the noise attenuation level to between 1 and 10.

### WIDTH (Default: 50)

Adjust the blanking duration time to between 1 and 100.

## Noise Reduction

### SSB, CW, RTTY, AM, FM and DV modes

The Noise Reduction function reduces random noise components and enhances signal audio.

Push **[NR]** to turn the Noise Reduction function ON or OFF.



### ◇ Adjusting the Noise Reduction level

Adjust the Noise Reduction level to where noise is reduced but the received signal is not distorted.

1. Hold down **[NR]** for 1 second.
  - Turns ON the Noise Reduction function and opens the NR menu.
2. Rotate **[MULTI]** to adjust the Noise Reduction level to between 0 and 15.
  - ① Adjust to a higher level to increase the reduction level, and a lower level to decrease it.

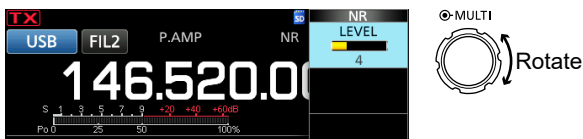

3. To close the NR menu, push **[EXIT]**.

Noise Reduction OFF  
NR level 0

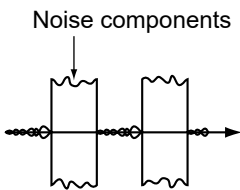

Noise Reduction ON  
NR level 4

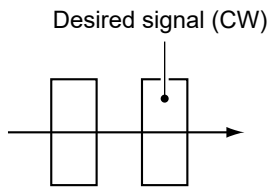

## Notch Filter

### SSB, CW, RTTY, AM and FM modes

The IC-9700 has Auto Notch and Manual Notch functions.

Auto Notch automatically attenuates beat tones, tuning signals and so on. It can be used in the SSB, AM and FM modes.

Manual Notch attenuates beat tones, tuning signals and so on by manually adjusting the filtering frequency. It can be used in the SSB, CW, RTTY and AM modes.

### ◇ Selecting the Notch filter type

Push **[NOTCH]** several times to select “AN (Auto Notch)” or “MN (Manual Notch).”

① Pushing **[NOTCH]** changes between “AN (Auto Notch),” “MN (Manual Notch)” and OFF.



### ◇ Setting the Manual Notch filter

When Manual Notch is selected, adjust the filtered frequency.

1. Hold down **[NOTCH]** for 1 second to display the NOTCH menu.
  - Opens the Notch menu.
  - The Manual Notch is automatically selected and “MN” is displayed.
2. Touch **[WIDTH]** several times to select the Manual Notch filter width from “WIDE,” “MID” and “NAR.”

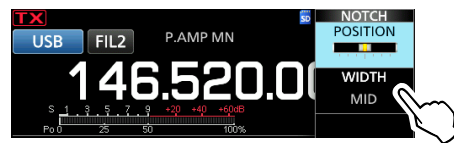

3. Rotate **[MULTI]** slowly, to manually attenuate the frequency.
4. To close the NOTCH menu, push **[EXIT]**.

**NOTE:** While adjusting, noise may be heard. This comes from the FPGA and does not indicate an equipment malfunction.

## Monitor function

The Monitor function enables you to monitor your transmit audio. Use this function to check the voice characteristics while adjusting transmit audio parameters.

① You can hear the CW sidetone regardless of the Monitor function setting.

1. Select the operating mode that you want to monitor. (Example: USB)
2. Push **FUNCTION**.
  - Opens the FUNCTION screen.
3. Touch **[MONI]** to turn ON the Monitor function.
  - ① Touching **[MONI]** turns the Monitor function ON or OFF.



4. If you want to adjust the monitor audio output, touch **[MONI]** for 1 second.
5. Rotate **⊕MULTI** to adjust MONITOR to the clearest audio output between 0% and 100%, while speaking at your normal voice level.

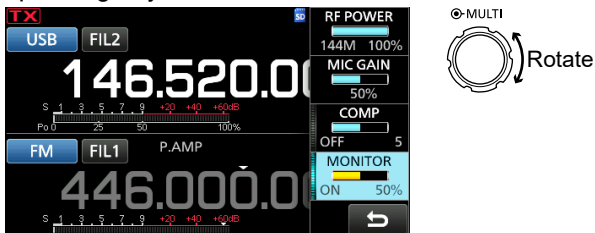

6. To close the Multi-function menu, push **⊕MULTI**.

**NOTE:** When using the VOX function, turn OFF the Monitor function. Otherwise the transmitted audio will echo.

## IP Plus function

The IP Plus function improves the Intermodulation Distortion (IMD) quality by exerting the direct sampling system performance.

This function optimizes the Analog/Digital Converter (ADC) against the distortion when you receive a strong input signal. It also improves the Third-order Intercept Point (IP3) while minimizing the reduction of the receive sensitivity.

1. Push **FUNCTION**.
  - The FUNCTION screen is displayed.
2. Touch **[IP+]**.
  - ① Touch **[IP+]** to turn the IP Plus function ON or OFF.
  - ② Select ON to prioritize the IP quality, and select OFF to prioritize the receive sensitivity.

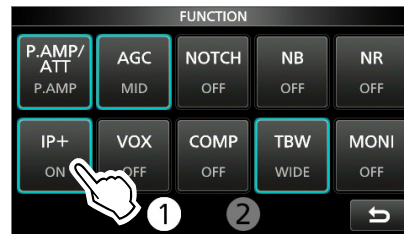

3. To close the FUNCTION screen, push **EXIT**.

## Setting the Speech Compressor

### SSB mode

The Speech Compressor increases the average RF output power, improving readability at the receiving station. This function compresses the transmitter audio input to increase the average audio output level.

① The function is effective for long-distance communication, or when propagation conditions are poor.

### ◇ Setting before using the Speech Compressor function

1. Select the SSB mode.  
(Example: USB)
2. Push **FUNCTION**.  
• Opens the FUNCTION screen.
3. Be sure the Speech Compressor is OFF.  
① If it is ON, touch [COMP] to turn it OFF.



4. Push **EXIT** to close the FUNCTION screen.
5. Touch the Multi-function meter to display the ALC meter.

① Touching the Multi-function meter sets the meter to Po, SWR, ALC, COMP, Vd or Id.

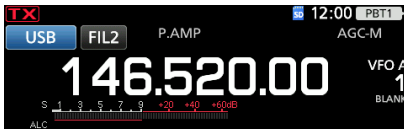

ALC meter

6. Push **MULTI** to display the Multi-function menu.
7. Touch [MIC GAIN], and then adjust it by speaking into the microphone to where the ALC meter reads within the 30 to 50% range of the ALC zone.

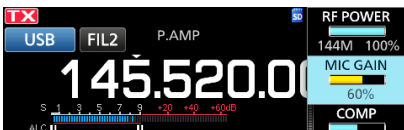

ALC zone

### ◇ Using the Speech Compressor function

1. Touch the Multi-function meter again to display the COMP meter.
2. Push **FUNCTION**.  
• Opens the FUNCTION screen.
3. Touch [COMP] to turn it ON.
4. Touch [COMP] for 1 second.
5. While speaking into the microphone at your normal voice level, adjust the Speech Compressor level to where the COMP meter reads within the COMP zone (10 to 20 dB range).  
① If the COMP meter peaks exceed the COMP zone, your transmitted voice may be distorted.

Speech Compressor is ON

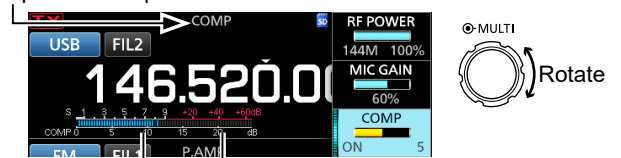

COMP zone

6. To close the COMP menu, push **EXIT**.

## AFC function

### FM and DV modes

The Automatic Frequency Control (AFC) function tunes the receive frequency to the incoming signal.

- ① This function activates regardless of the squelch condition.
- ① When the Split function is ON, the transmit frequency is not tuned into the incoming signal.

### ● Push **AFC**.

① Pushing **AFC** turns the AFC function ON or OFF.

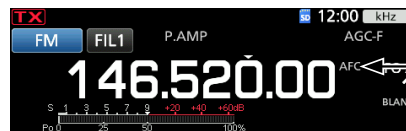

Displayed when the AFC function is ON.

- ① You can also turn the AFC function ON or OFF on the FUNCTION screen.
- ① You can select whether or not to limit the operating range for this function. (Default: ON)

**MENU** » **SET** > Function > **AFC Limit**

When "AFC Limit" is set to "OFF," this function may tune the receive frequency to a strong signal near the desired signal.

## Split frequency operation

Split frequency operation enables you to transmit and receive on different frequencies in the same band.

There are 2 ways to use Split frequency operation.

- Use the Quick Split function
- Use the receive and transmit frequencies set to VFO A and VFO B.

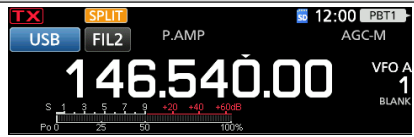
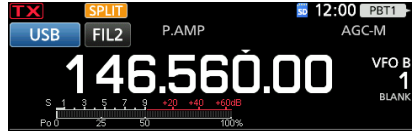
The other station		My station	
Transmit frequency	USB mode 146.540 MHz	VFO A Receive frequency	
Receive frequency	USB mode 146.560 MHz	VFO B Transmit frequency	

### ◇ Using the Quick Split function

The Quick Split function enables you to automatically equalize the frequency and mode of VFOs to the displayed VFO, and activate the Split function.

1. Set VFO A's receive frequency and operating mode.  
(Example: 146.540 MHz in the USB mode)
2. Hold down **[SPLIT]** for 1 second.
  - The Quick Split function is turned ON and the VFO A settings are set to VFO B.

Displayed

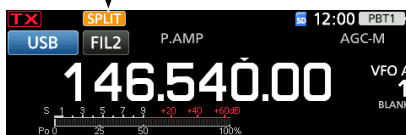

3. While holding down **[XFC]**, set the operating frequency offset between transmit and receive.  
(Example: 20.00 kHz)

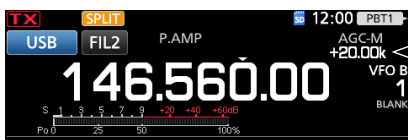

The offset between transmit and receive while holding down **[XFC]**.

### ◇ Using the receive and transmit frequencies set to VFO A and VFO B

1. Set VFO A's receive frequency and operating mode.  
(Example: 146.540 MHz in the USB mode)

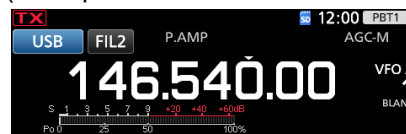

2. Push **[A/B]** to select VFO B, and then set the receive frequency and the operating mode.  
(Example: 146.560 MHz in the USB mode)

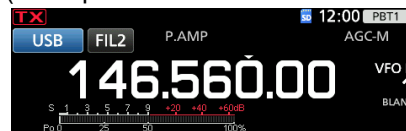

3. Push **[SPLIT]** to turn ON the Split function.  
① Pushing **[SPLIT]** turns the Split function ON or OFF.

Displayed

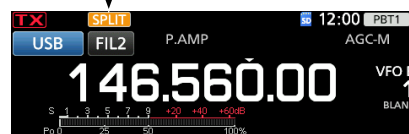

4. Push **[A/B]** to return to VFO A.  
① The Split frequency operation is ready.

## Split Lock function

To prevent accidentally changing the receive frequency by releasing **(XFC)** while rotating **(MAIN DIAL)**, use the Split Lock function. Using both this function and the Dial Lock function enables you to change only the transmit frequency.

1. Turn ON the Split Lock function.  
**(MENU)** » **SET > Function > SPLIT > SPLIT LOCK**
2. Turn ON the Split function.
3. Hold down **(SPEECH)** for 1 second to turn ON the Dial Lock function.
4. While holding down **(XFC)**, set the transmit frequency.

## Setting the transmit filter width

### SSB mode

The transmit filter width for the SSB and SSB-D modes can be set. Only for the SSB mode, WIDE (wide), MID (middle) or NAR (narrow) can be selected.  
 ① The filter can be independently set on the speech compressor function is ON or OFF.

#### To change the filter width in the SSB mode:

1. Set the operating mode to USB or LSB.
2. Push **(FUNCTION)**.  
 • Opens the FUNCTION screen.
3. Touch **[TBW]**.  
 ① Touching **[TBW]** sets the filter width to WIDE, MID or NAR.



The transmit filter widths are set to the following values by default.

- SSB (WIDE): 100 Hz to 2900 Hz
- SSB (MID): 300 Hz to 2700 Hz
- SSB (NAR): 500 Hz to 2500 Hz
- SSB-D: 300 Hz to 2700 Hz

① You can change the filter width values in the following settings.

- (MENU)** » **SET > Tone Control/TBW > TX > SSB > TBW (WIDE)**
- (MENU)** » **SET > Tone Control/TBW > TX > SSB > TBW (MID)**
- (MENU)** » **SET > Tone Control/TBW > TX > SSB > TBW (NAR)**
- (MENU)** » **SET > Tone Control/TBW > TX > SSB-D > TBW**

## Operating CW

### ◇ Setting the CW pitch control

You can set the received CW audio pitch and the CW side tone to suit your preference without changing the operating frequency.

1. Select the CW mode.
2. Display the Multi-function menu.

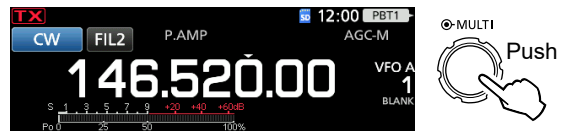

3. Touch **[CW PITCH]**.

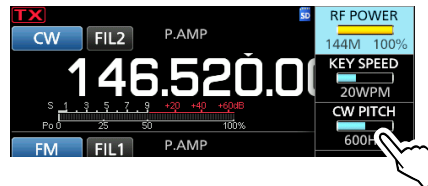

4. Set the CW pitch to between 300 and 900 Hz (in 5 Hz steps).
5. Push **(MULTI)** to close the Multi-function menu.

### ◇ Setting the key speed

You can set the keying speed of the internal electronic keyer.

1. Select the CW mode.
2. Display the Multi-function menu.

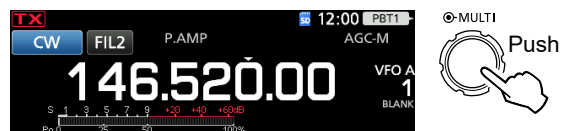

3. Touch **[KEY SPEED]**.

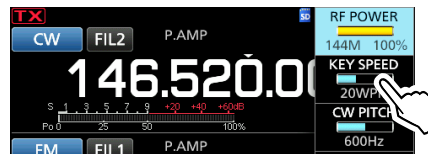

4. Set the key speed to between 6 and 48 Words Per Minute (WPM).
5. Push **(MULTI)** to close the Multi-function menu.

## Operating CW (Continued)

## ◇ Using the Break-in function

Use the Break-in function in the CW mode to automatically switch between transmit and receive when keying. The IC-9700 is capable of Semi Break-in and Full break-in modes.

**TIP:** The key type is set to “Paddle” by default. You can select the keyer type on the CW-KEY SET screen. (p. 4-12)

## Semi Break-in operation

In the Semi Break-in mode, the transceiver transmits when keying, and then automatically returns to receive after a preset time after you stop keying.

1. Select the CW mode.
2. Push **VOX/BK-IN** to display “BKIN.”  
① Pushing **VOX/BK-IN** selects “BKIN (Semi Break-in),” “F-BKIN (Full Break-in)” or OFF (no indication).

Semi Break-in

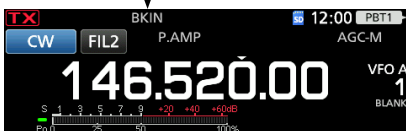

3. To adjust the Break-in delay time, hold down **VOX/BK-IN** for 1 second.
  - Opens the BKIN menu.
4. Set to where the transceiver does not return to receive while keying.

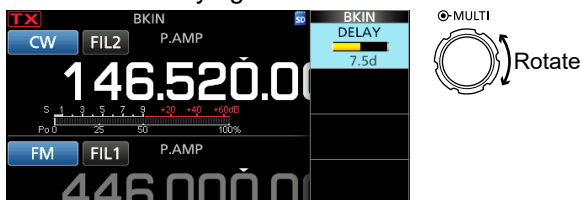

① When you are using a paddle, push **(MULTI)** to display the Multi-function menu, and then adjust the KEY SPEED (p. 4-10) while operating the paddle.

5. To close the BKIN menu, push **EXIT**.

## Full Break-in operation

In the Full Break-in mode, the transceiver automatically transmits while keying down, and then immediately returns to receive after keying up.

1. Select the CW mode.
2. Push **VOX/BK-IN** several times to select “F-BKIN.”  
① Pushing **VOX/BK-IN** selects “BKIN (Semi Break-in),” “F-BKIN (Full Break-in)” or OFF (no indication).

Full Break-in



3. Use a straight key or paddle.  
① In the Full break-in mode, the transceiver automatically returns to receive without a preset break-in delay time after you stop keying. The transceiver receives while keying up.

## ◇ Monitoring the CW side tone

When the transceiver is in standby and the Break-In function is OFF, you can listen to the CW side tone without actually transmitting.

## ① Information

- This enables you to match your transmit frequency exactly to another station's by matching the audio tone.
- You can also use the CW side tone (make sure the Break-in function is OFF to practice CW sending).
- You can adjust the CW side tone level in “Side Tone Level.”

**MENU** » **KEYER > EDIT/SET > CW-KEY SET > Side Tone Level**

Operating CW (Continued)

◆ About the electronic Keyer function

You can set the Keyer Memory function settings, paddle polarity settings, and so on of the Electronic Keyer.

1. Select the CW mode.
2. Open the KEYER screen.



3. Touch [EDIT/SET].
  - Opens the EDIT/SET screen.



KEYER screen

4. Select the desired item to set.

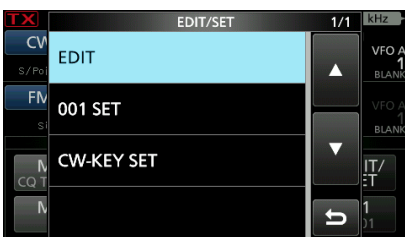

EDIT/SET screen

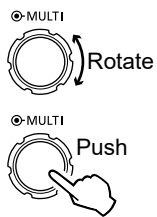

EDIT

**KEYER MEMORY edit menu**  
You can edit the Keyer memories M1 to M8.

001 SET

**KEYER 001 contest number menu**  
• You can set the following items.  
• Number Style  
• Count Up Trigger  
• Present Number

CW-KEY SET

**CW-KEY SET menu**  
• You can set the following items.  
• Side Tone Level  
• Side Tone Level Limit  
• Keyer Repeat Time  
• Dot/Dash Ratio  
• Rise Time  
• Paddle Polarity  
• Key Type  
• MIC Up/Down Keyer

5. To close the KEYER screen, push **EXIT** several times.

## Spectrum scope screen

The spectrum scope enables you to display the activity on the selected band, as well as the relative strengths of various signals.

The transceiver has three spectrum scope modes, the Center mode, the Fixed mode, and the Scroll mode. You can also turn the Waterfall display ON or OFF. In addition, you can select the Mini scope to display it in a smaller size on the screen.

### Center mode screen

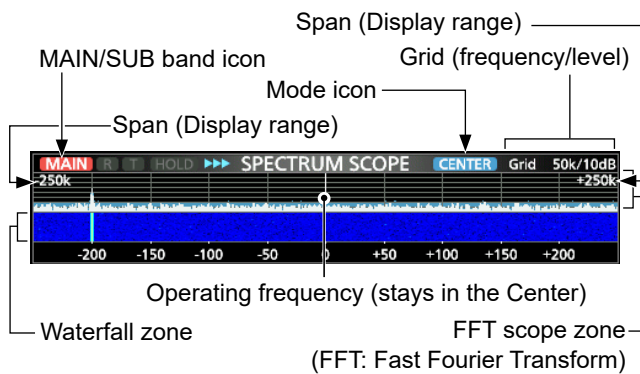

### Fixed mode screen

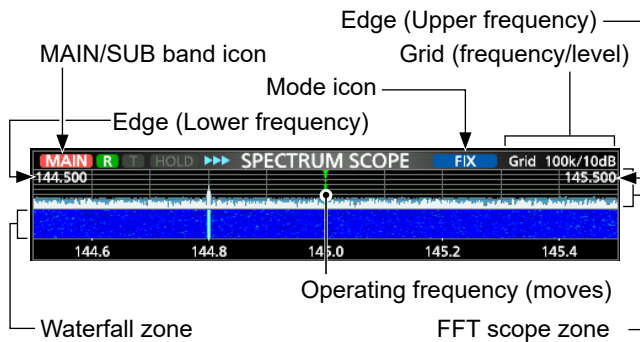

### Scroll mode screen

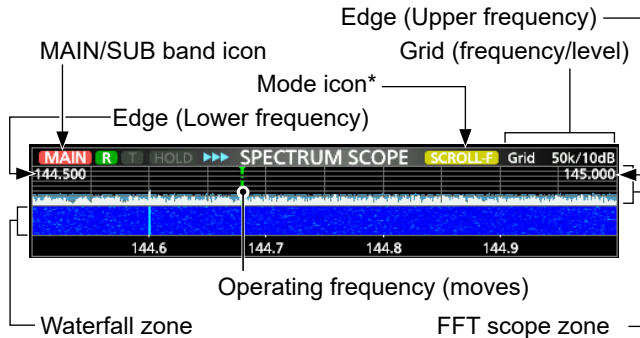

\* When in the SCROLL-C mode, **SCROLL-C** is displayed.

### Using the Spectrum Scope

Display the SPECTRUM SCOPE screen.

**[MENU]** » **SCOPE**

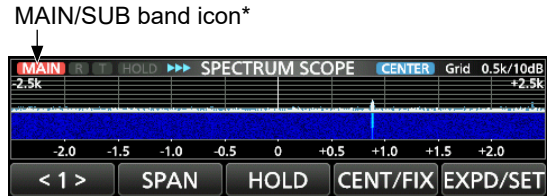

MENU 1: Center/Scroll-C mode



MENU 1: Fix/Scroll-F mode



MENU 2: Center/Fix/Scroll-C/Scroll-F mode

\* Touch the MAIN/SUB band icon selects the displayed band.

Key	Action	
< 1 > < 2 >	Selects the Function menus.	
SPAN	Touch	In the Center mode and the Scroll-C mode, selects the scope span. • Spans: $\pm 2.5$ , 5.0, 10, 25, 50, 100, 250 and 500 kHz
	Touch for 1 second	Resets to the $\pm 2.5$ kHz span.
EDGE	In the Fixed mode and the Scroll-F mode, selects the Edge frequencies. ① You can set the upper and lower edge frequencies in the "Fixed Edges" item on the SCOPE SET screen by touching [EXPD/SET] for 1 second.	
HOLD	Touch	Sets the Hold function to ON or OFF. • "HOLD" and the Marker are displayed. Freezes the current spectrum.
	Touch for 1 second	Clears the Peak Hold level.
CENT/FIX	Touch	Selects the Center or Fixed mode.
	Touch for 1 second	Selects the Scroll mode.
EXPD/SET	Touch	Selects the Expanded or Normal screen.
	Touch for 1 second	Displays the SCOPE SET screen. ① See the Advanced Manual for details.
REF	Opens the Reference level window. ① Rotate <b>(MAIN DIAL)</b> to adjust the Reference level. ① Touch again to close the window.	
SPEED	Selects the sweep speed. • "▶▶▶" (FAST), "▶▶" (MID), or "▶" (SLOW).	
MARKER	Selects the Marker.	

Spectrum scope screen (Continue)

◇ Center mode

Displays signals around the operating frequency within the selected span. The operating frequency is always displayed in the center of the screen.

1. Display the SPECTRUM SCOPE screen.  
 [MENU] » [SCOPE]
2. Touch [CENT/FIX].  
 ① Touch [CENT/FIX] to toggle between the Center and Fixed modes.
3. Touch [SPAN] several times to select the scope span.  
 • ±2.5, 5.0, 10, 25, 50, 100, 250 and 500 kHz  
 ① Touch [SPAN] for 1 second to select the ±2.5 kHz span.

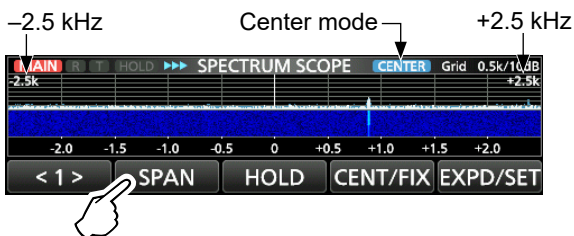

◇ Fixed mode

Displays signals within a specified frequency range. The selected frequency band activity can easily be observed in this mode. Four Fixed Edge bands can be set for each amateur frequency band covered by the transceiver in the SCOPE SET screen.

1. Display the SPECTRUM SCOPE screen.  
 [MENU] » [SCOPE]
2. Touch [CENT/FIX].  
 ① Touch [CENT/FIX] to toggle between the Center and Fixed modes.
3. Touch [EDGE] several times to select the Edge frequency.  
 ① When the operating frequency moves outside the upper or lower edge frequency, ">>" or "<<" is displayed in the upper side corners of the SPECTRUM SCOPE screen.  
 >>: The frequency is outside the higher edge.  
 <<: The frequency is outside the lower edge.  
 When the frequency goes further away, "Scope Out of Range" is displayed.

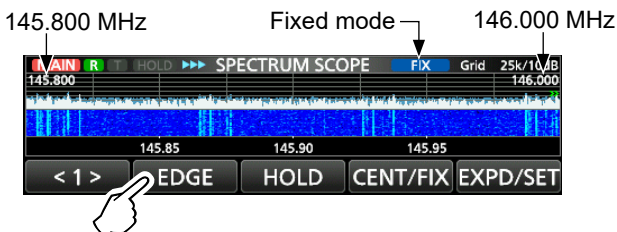

◇ Scroll mode

Displays signals within a selected span. When the operating frequency moves outside of the screen, the displayed frequency range is automatically scrolled.

1. Display the SPECTRUM SCOPE screen.  
 [MENU] » [SCOPE]
2. Touch [CENT/FIX] for 1 second to select the Scroll mode.  
 • When changing the Center mode to the Scroll mode, "SCROLL-C" is displayed. You can change the scope span by touching [SPAN].  
 • When changing the Fixed mode to the Scroll mode, "SCROLL-F" is displayed. You can change the Edge frequencies by touching [EDGE].
3. Touch [CENT/FIX] to return to the previous mode.  
 • When returning to the Center mode, the scope span does not return to the previous setting.  
 • When returning to the Fixed mode, the Edge frequencies return to the last selected "Fixed Edges." If the operating frequency is above the upper Edge frequency, or below the lower Edge frequency, ">>" or "<<" is displayed in the upper side corners of the SPECTRUM SCOPE screen.

◇ Marker

The Marker displays the operating frequency in the SPECTRUM SCOPE screen.

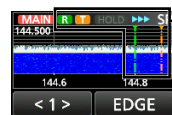

- **R**: The RX marker displays the receive frequency.
- **T**: The TX marker displays the transmit frequency.

• About RX Marker

In the Fixed mode, the RX Marker displays the operating frequency within a specified frequency range. So, the transceiver always displays the RX marker in the scope screen. In the Center mode, the operating frequency stays on the Center of the screen. Thus, the transceiver does not display the RX Marker.  
 ① When the Hold function is ON, the RX Marker is displayed to indicate the operating frequency's position.

**Spectrum scope screen (Continue)**

**◇ Touch screen operation**

When you touch the FFT scope zone or the waterfall zone in the SPECTRUM SCOPE screen, the area will be zoomed in. Then you touch the signal in the zoomed area, you can directly tune your frequency to the signal in the SPECTRUM SCOPE screen.

① Holding down **XFC** changes the transmit frequency.

1. Display the SPECTRUM SCOPE screen.



2. Touch the Scope screen.
  - The area around the touched point is zoomed in.

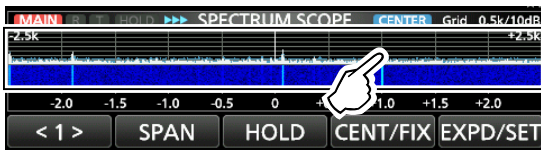

3. Touch the signal in the zoomed area.

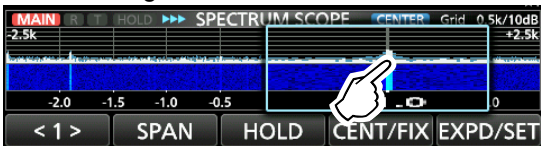

**① Information**

- In the Center mode, the operating frequency changes to the touched point, and the point moves to the screen center.
- In the Fixed mode, the operating frequency and marker change to the touched point.
- Touch out of the zoomed area to close the zoomed window.

**◇ Mini scope screen**

The Mini scope screen can be simultaneously displayed with another function displays, such as the RTTY DECODE screen and the AUDIO SCOPE screen.

① The Mini scope screen cannot be used when the Dualwatch function is ON.

Push **M.SCOPE** to turn the Mini scope screen ON or OFF.

① Hold down **M.SCOPE** for 1 second to display the SPECTRUM SCOPE screen.

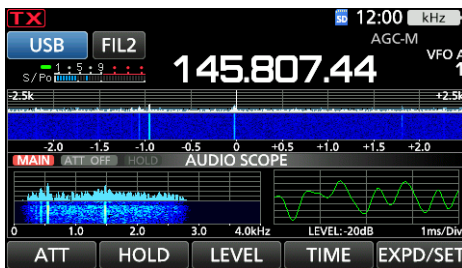

Mini scope screen with the AUDIO SCOPE screen

**Audio scope screen**

This audio scope enables you to display the received signal's frequency component on the FFT scope, and its waveform components on the Oscilloscope. The FFT scope also has a waterfall.

Display the AUDIO SCOPE screen.

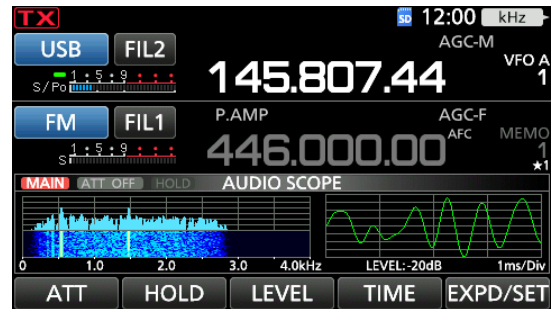

AUDIO SCOPE screen

Key	Action	
ATT	Touch	Selects the attenuator for the FFT scope. • 0 (OFF), 10, 20, or 30 dB
	Touch for 1 second	Turns OFF the attenuator. (0 dB)
HOLD	Sets the Hold function to ON or OFF. • " <b>(HOLD)</b> " is displayed and freezes the current audio spectrum.	
LEVEL	Selects the Oscilloscope level. • 0, -10, -20, or -30 dB	
TIME	Selects the Oscilloscope sweep time. • 1, 3, 10, 30, 100, or 300 ms/Div	
EXPD/SET	Touch	Selects the Expanded or Normal screen.
	Touch for 1 second	Enters the AUDIO SCOPE SET screen. ① See the Advanced Manual for details.

**• AUDIO SCOPE screen**

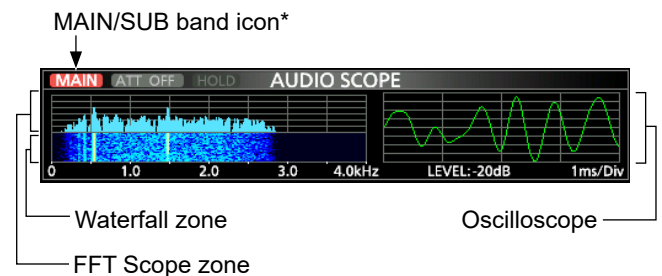

\*Touching the MAIN/SUB band icon selects the displayed band.

**NOTE:** SD cards, SDHC cards, and SDXC cards are user supplied.

**TIP:** Icom recommends that you save the transceiver's factory default data for backup.

## About the SD cards

You can use an SD card of up to 2 GB, an SDHC of up to 32 GB, or an SDXC of up to 256 GB. Icom has checked the compatibility with the following cards.  
(As of January 2026)

Brand	Type	Capacity
SanDisk®	SD	2 GB
	SDHC	4/8/16/32 GB
	SDXC	64/128/256 GB

- ① The above list does not guarantee the card's performance.
- ① Throughout the rest of this document, the SD cards, SDHC cards, and SDXC cards are simply called the SD card or the card.

### NOTE:

- Before using the SD card, thoroughly read the instructions that came with the card.
- If any of the following occur, the card's data may be corrupted or deleted.
  - You remove the card from the transceiver while it is still accessing the card.
  - A power failure occurs, or the power cable is disconnected, while accessing the card.
  - You drop, impact or vibrate the card.
- Do not touch the contacts of the card.
- The transceiver may take a longer time to recognize a high capacity card.
- The card has a certain lifetime, so data reading or writing may not be possible after using it for a long period of time. If reading or writing data is impossible, the card's lifetime may have ended. In that case, use a new one.
- We recommend that you make a separate backup file of the important data onto your PC.
- Icom will not be responsible for any damage caused by data corruption on an SD card.

## Saving data

You can save the following data onto the card.

- Data settings and Memory channel contents of the transceiver
- Communication/receive log and contents
- Automatic answering voice audio in the DV mode
- Voice audio for the Voice TX function
- RTTY decode log      • Captured screens
- Your (UR) call sign memory
- Repeater List      • GPS memory
- Pictures for the Share Pictures function
- Transmitted and received log of Share Pictures

## Inserting

Insert the SD card as shown below.

- ① Insert the SD card into the slot until it locks in place, and makes a 'click' sound.
- ① Be sure to check the card orientation before inserting.

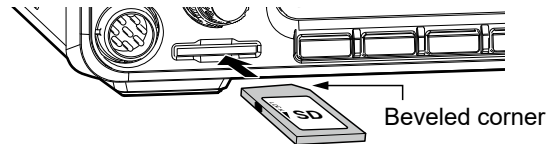

### NOTE:

**Before using an SD card for the first time, be sure to format it in the transceiver.**

- Formatting a card erases all its data.
- Before formatting any used card, back up its data onto your PC.
- After inserting or formatting, a special folder on the card that you need for operations like updating the firmware is created on the card.

**IMPORTANT:** Even if you have formatted an SD card, some data may remain in the card. When you dispose the card, be sure to physically destroy it to avoid unauthorized access to any data that remains.

## Formatting

Before using an SD card, format it to be used with the transceiver by doing the following steps.

1. Open the SD CARD screen.  
**MENU** » **SET > SD Card**
2. Touch "Format."

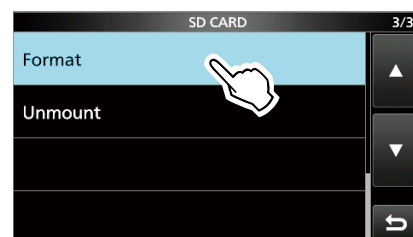

3. Touch [YES] to start formatting.

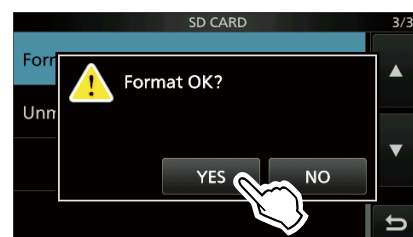

- After formatting, returns to the SD CARD screen.
- ① To cancel formatting, touch [NO].
- 4. To close the SD CARD screen, push **EXIT** several times.

## Unmounting

Before you remove a card when the transceiver is ON, be sure to electrically unmount it, as shown below. Otherwise the data may be corrupted or deleted.

1. Open the SD CARD screen.

**MENU** » **SET > SD Card**

2. Touch “Unmount.”

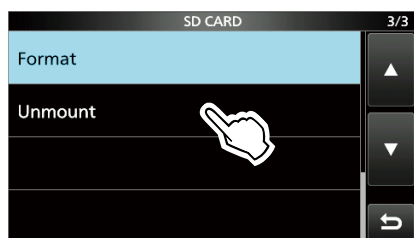

3. Touch [YES] to unmount.

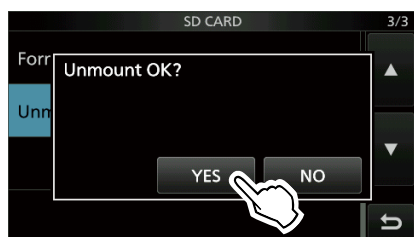

• After unmounting, returns to the SD CARD screen.

① To cancel unmounting, touch [NO].

4. Remove the card from the transceiver.

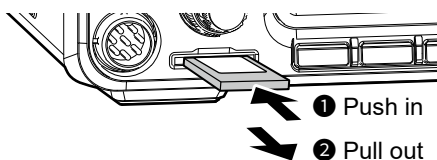

① Push in the SD card until a click sounds to unlock the card, and then pull it out.

5. To close the SD CARD screen, push **EXIT** several times.

### When the transceiver is OFF

You can remove the SD card starting from step 4 of the steps described above.

## Saving the setting data

The Memory channels and the transceiver's settings can be saved onto an SD card.

1. Open the SAVE SETTING screen.

**MENU** » **SET > SD Card > Save Setting**

2. Touch “<<New File>>.”

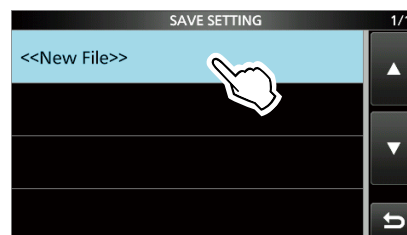

① The file name is automatically set in the following format: Setyyyyymmdd\_xx (yyyy: Year, mm: month, dd: day, xx: serial number).

3. To save the file with the displayed name, touch [ENT].



① If you want to change the name, delete the name and reenter it, and then touch [ENT].

4. Touch [YES].

• Saves the data settings.

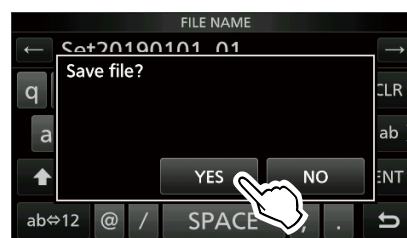

5. To close the SD CARD screen, push **EXIT** several times.

**TIP:** When you have updated the transceiver's firmware, the “Save Form” item will be added on the setting screen.

If this item is set to the earlier firmware version, the confirmation window is displayed after step 2. To save the data in the earlier firmware version, touch [YES].

## Loading the saved data

You can load the Memory channels and transceiver's settings from the SD card to the transceiver.

1. Open the LOAD SETTING screen.  
MENU » SET > SD Card > Load Setting

2. Touch the file to load.

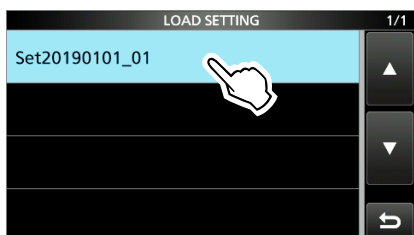

3. Touch "Select."

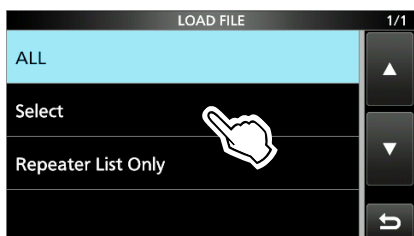

- ① If you want to load all the contents on the LOAD OPTION screen, touch "ALL" and go to step 6.
- ① If you want to load only the repeater list, touch "Repeater List Only" and go to step 6.

4. Touch the loading options. (Example: CI-V Address)

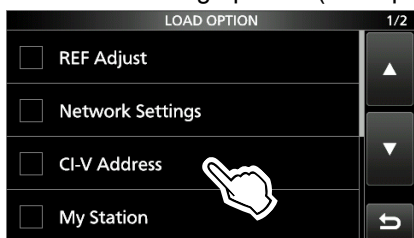

- "✓" is displayed left side of the selected option.
- ① The Set mode settings and Memory channel contents are always loaded.

5. Touch "<<Load>>."

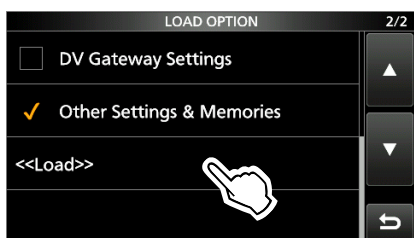

- "Keep 'SKIP' settings in the Repeater List?" is displayed.

6. Touch [YES] or [NO].

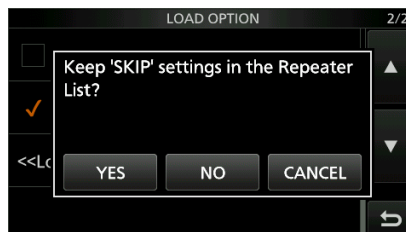

- "Load file?" is displayed.
  - ① When you touch [YES], the skip settings of the repeater list are retained.
  - ① When you touch [NO], the skip settings of the repeater list are cleared.
7. Touch [YES].
    - After the loading ends, "COMPLETED! Restart the IC-9700." is displayed.
    - ① When you select "REF Adjust" in step 4, "The new "REF Adjust" setting will be saved" is displayed.
  8. Turn OFF the transceiver power, then turn it ON again to restart the transceiver.

## Deleting a data file

Follow the steps below to delete the files you no longer need on the SD card.

**NOTE:** Deleted data from a card cannot be recalled. Before deleting any data, back up the card data onto your PC.

1. Open the SAVE SETTING screen.  
**MENU** » **SET > SD Card > Save Setting**

2. Touch the file to delete for 1 second.

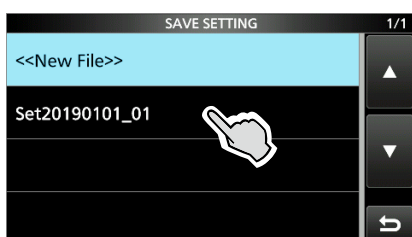

3. Touch "Delete."

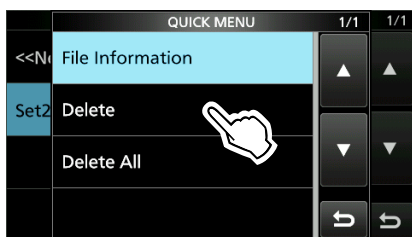

- ① To delete all files, touch "Delete All."
- ① To cancel deleting, push **EXIT**.

4. Touch [YES].

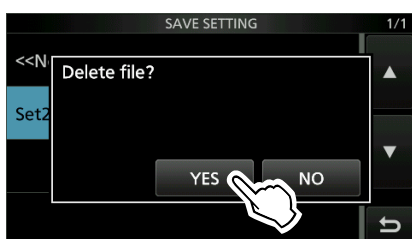

5. To close the SET screen, push **EXIT** several times.

### Checking the file information

Touch "File Information" on the QUICK MENU to display the file name, size and the saved date.

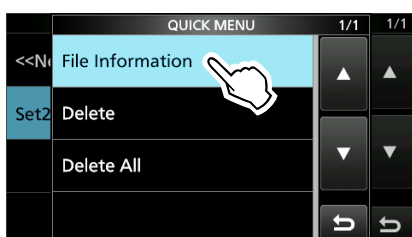

## Displaying the card information

You can display the SD card capacity, and the time remaining for voice recording.

1. Open the SD CARD screen.  
**MENU** » **SET > SD Card**
2. Touch "SD Card Info."

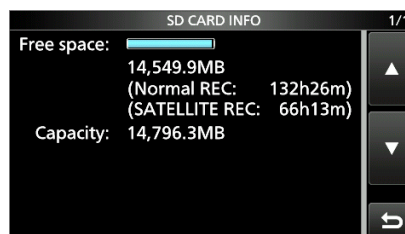
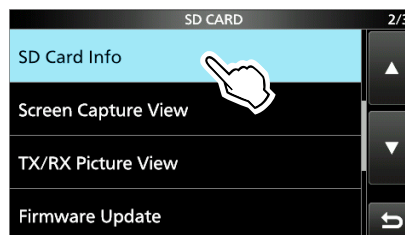

3. To close the SET screen, push **EXIT** several times.

## Importing or Exporting a CSV format file

Please read this section before importing or exporting a Comma Separated Values (CSV) format file from the SD card.

You can import or export the following data:

- Your Call Sign Memory
- Repeater List
- GPS Memory

**NOTE:**

- Before importing, make a backup file of all the transceiver’s data to the SD card in case of data loss.
- The transceiver cannot display a file that has a file name longer than 24 characters. In this case, rename it using 23 characters or less. When you export the data in a CSV format file using the CS-9700, BE SURE to name it using 23 characters or less.

### ◇ Importing

1. Open the IMPORT/EXPORT screen.  
**MENU** » **SET > SD Card > Import/Export**

2. Touch “Import.”



3. Touch the data to import. (Example: Your Call Sign)

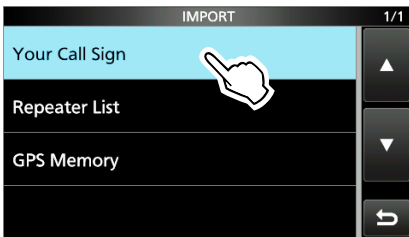

4. Touch the CSV file to import.

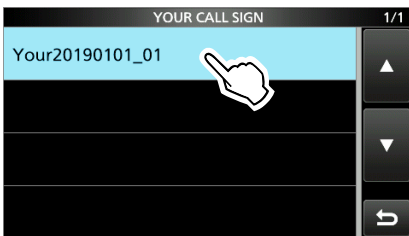

5. Touch [YES].

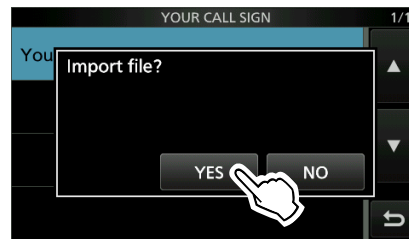

- Starts to import.
- ① After importing ends, “COMPLETED!” is displayed.
- ① To complete the importing, restart the transceiver.

**TIP:** To import a repeater list, see the ADVANCED MANUAL for details.

## Importing or Exporting a CSV format file (Continued)

### ◇ Exporting

1. Open the IMPORT/EXPORT screen.

**MENU** » **SET > SD Card > Import/Export**

2. Touch "Export."



3. Touch the data to export. (Example: Your Call Sign)

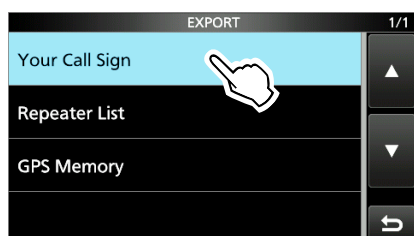

4. Touch "<<New File>>."

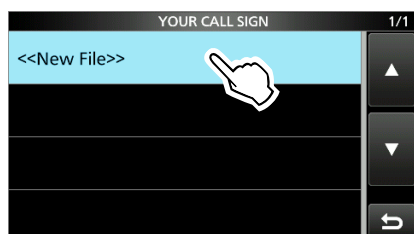

① The file name is automatically set in the following format: Your\*yyyymmdd\_xx (yyyy: Year, mm: month, dd: day, xx: serial number).

\* "Rpt" is displayed for a repeater list, and "Gps" is displayed for a GPS memory.

5. To save the file with the displayed name, touch [ENT].

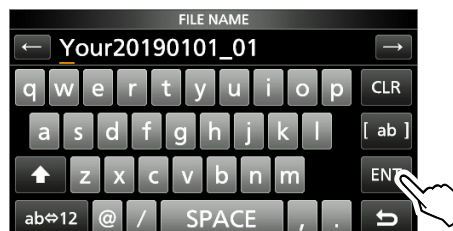

① If you want to change the name, delete the name and reenter it, and then touch [ENT].

6. Touch [YES].

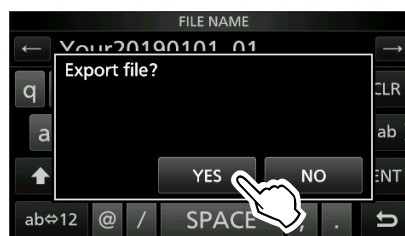

7. To close the EXPORT screen, push **EXIT** several times.

## About the SD card folders

You can easily restore data with a backup file, even if the setting data in the SD card is accidentally deleted.

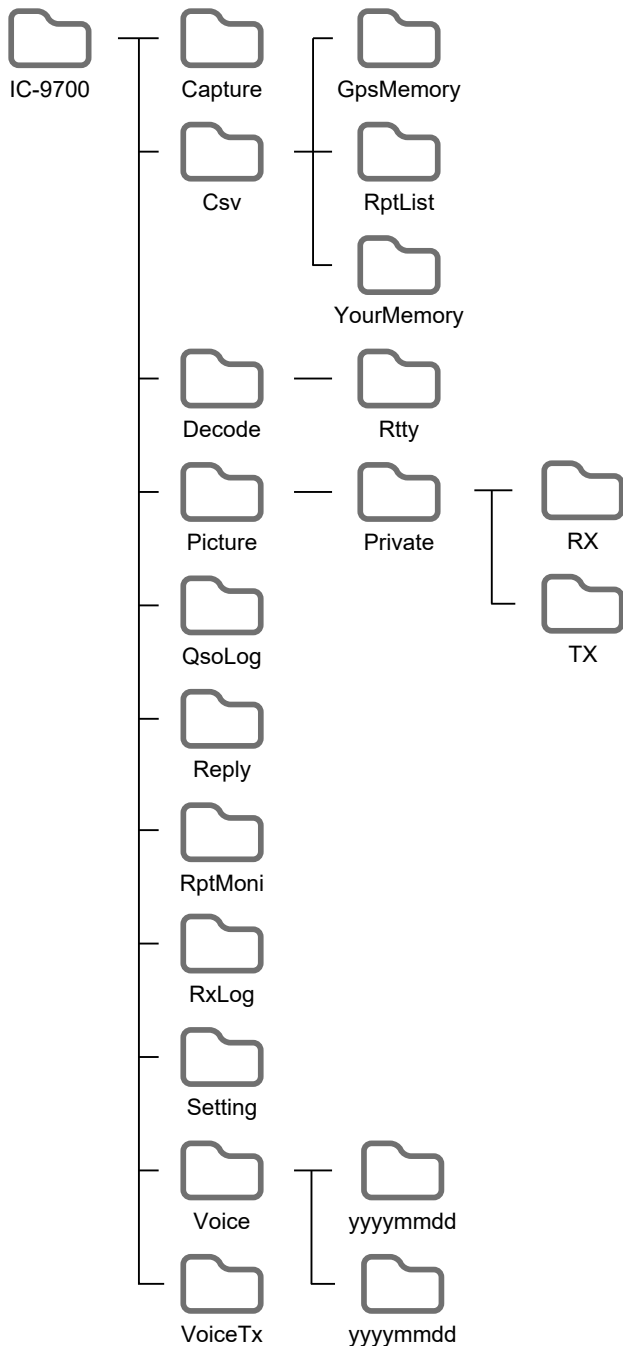

The folder in the SD card contains the following.

- **IC-9700 folder**  
The folders created in the IC-9700 are contained in this folder.
- **Capture folder**  
Saves the captured screen data in the “png” or “bmp” format.

- **Csv folder**  
Contains the GPS Memory, Repeater List and Your Call Sign Memory folders.
- **GpsMemory folder**  
Saves the Gps Memory in the “csv” format to import.
- **RptList folder**  
Saves the Repeater List in the “csv” format to import.
- **YourMemory folder**  
Saves the Your Call Sign Memory in the “csv” format to import.
- **Decode folder**  
Saves the RTTY decode log.
- **Rtty folder**  
Saves the transmitted or received RTTY decode log data in the “txt” or “html” format.
- **Picture folder**  
Saves the pictures in the “jpg” format that are used with the Share Pictures function.
- **Private folder**  
Saves RX Picture History and TX Picture History.
- **Rx folder**  
Saves RX Picture History in the “dat” format.  
①The RX Picture History contents are not displayed on the PC.
- **Tx folder**  
Saves TX Picture History in the “dat” format.  
①The TX Picture History contents are not displayed on the PC.
- **QsoLog folder**  
Saves QSO log data in the “csv” format.
- **Reply folder**  
Saves Automatic reply data in the “wav” format.
- **RptMoni folder**  
Contains the DV repeater IP address list in the “csv” format.
- **RxLog folder**  
Saves RX record log data in the “csv” format.
- **Setting folder**  
Saves the transceiver’s setting data in the “icf” format.
- **Voice folder**  
Creates the recorded QSO audio date folders.
- **yyyyymmdd folder**  
Saves the recorded audio file in the “wav” format.  
The folder name is automatically created in the following format:  
yyyyymmdd (yyyy: year, mm: month, dd: day)
- **VoiceTx folder**  
Saves the recorded voice audio data for the Voice TX function in the “wav” format.

## Satellite communications outline

Both Satellite Mode B (435 MHz uplink, 145 MHz downlink), Mode J (145 MHz uplink, 435 MHz downlink) and Mode L (1270 MHz uplink, 435 MHz downlink) can be operated. Preamplifier (user supplied) may help receiving weak signals.

**Satellite information:**  
Satellite information describes satellite location, orbit angles, and so on. Such information may be available in ham magazines, organization publications or on web sites. Satellite tracking software is also convenient.

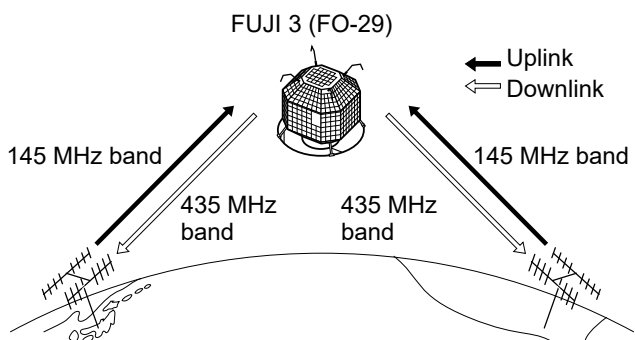

**Mode V/U operating diagram**  
[Example]: FUJI 3 (FO-29), Mode V/U  
Uplink frequency: 145.9000–146.0000 MHz  
Downlink frequency: 435.8000–435.9000 MHz  
Tracking direction: Reverse  
CW beacon frequency: 435.7950 MHz

## Selecting the satellite mode

Operating frequencies in the satellite mode can be selected either before or after selecting the mode. Normal and reverse tracking are selectable.

Enter the Satellite mode in the MENU.

**MENU** » **SATELLITE**

- Touch [SATELLITE] for 1 second, to copy the current frequency to the Satellite VFO.
- ① When the DR or DD mode is selected, the frequency is not copied.
- ① Touch [SATELLITE] for 1 second again, to exit the Satellite mode.

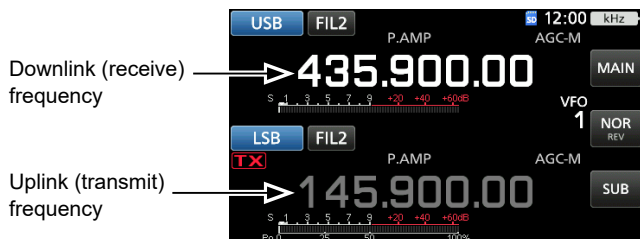

Key	Function
MAIN	Touch to select the Main band (Downlink frequency).
NOR REV	Change the tracking.
SUB	Touch to select the Sub band (Uplink frequency).

## ◇ Setting the satellite VFO

1. Touch [MAIN].
  - The Main band is selected.

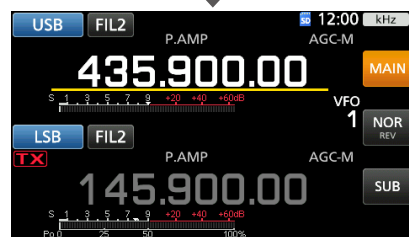

2. Rotate **MAIN DIAL** to set the downlink frequency.
3. Touch [SUB].
  - The Sub band is selected.

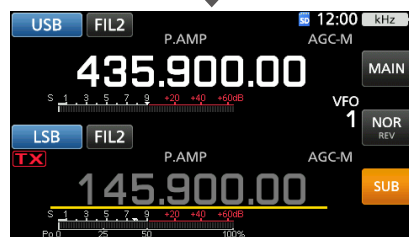
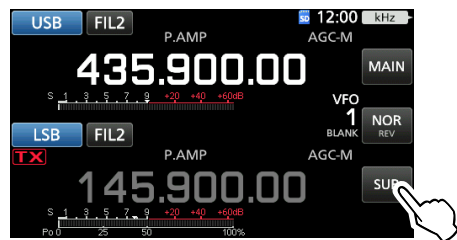

4. Rotate **MAIN DIAL** to set the uplink frequency.

## ◇ Selecting NOR/REV tracking

Touching [NOR REV] changes the frequency increment when rotating **MAIN DIAL**.

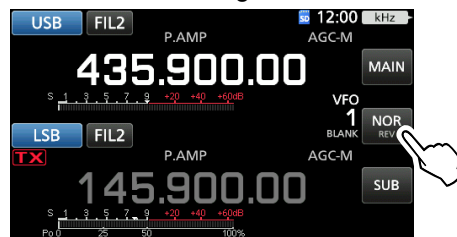

- NOR: Both downlink and uplink frequencies simultaneously increase or decrease in the same steps when you rotate **MAIN DIAL**.
- REV: The downlink frequency follows the tuning dial rotation, however, the uplink frequency changes in the reverse direction to the **MAIN DIAL** rotation, in the same steps.

## Loop test procedure

Decide on a usable satellite, and point your antenna towards it.

① Monitored audio may cause howling. Using headphones is recommended.

1. Set the downlink frequency (receive frequency) in the Main band to match the beacon frequency.

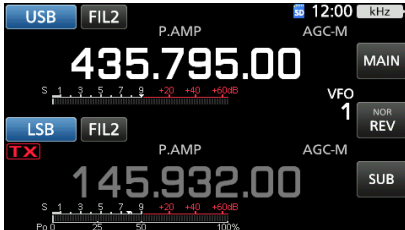

① The beacon frequency drifts (Doppler effect). Rotate **(MAIN DIAL)** to adjust the frequency.

2. When you can receive the beacon, rotate **(MAIN DIAL)** to select a frequency within the satellite's coverage, as the downlink frequency on the MAIN band.



① Select a vacant frequency within the satellite's coverage. Monitor the operating frequency to make sure transmitting won't cause interference to other stations.

3. Push [PTT] on the microphone to transmit. (or push **(TRANSMIT)** on the transceiver)
4. Touch [SUB].

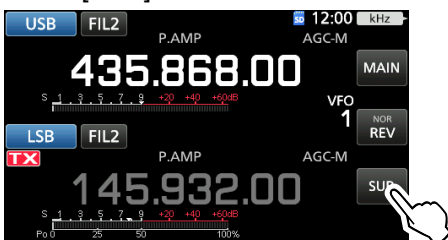

• The Sub band is selected.

### About the Loop test:

Loop test is a method to confirm the communication status between your station and the satellite. By transmitting your voice (Example: your call sign), check the received audio.

5. While rotating **(MAIN DIAL)**, speak at your normal voice level to the microphone.

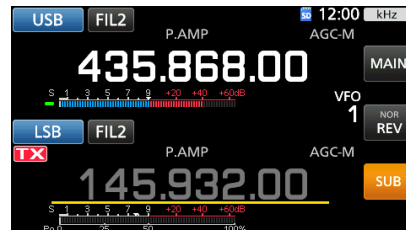

- Adjust the uplink frequency so that your voice is clearly heard.
6. Touch [SUB].
    - The Sub band is unselected.

### Using the spectrum scope

You can visually check the signal presence on the Spectrum Scope screen.

**(MENU)** » **(SCOPE)**

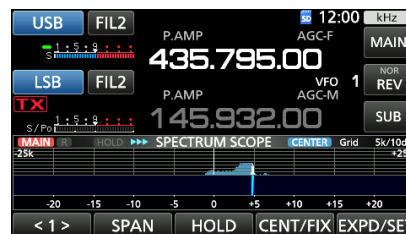

- ① By touching on the waterfall zone on the SPECTRUM SCOPE screen, you can directly tune your frequency on the displayed area of the band.
- ① Refer to Section 5 for details on the Scope screen.

### About the Doppler effect:

Since the speed of satellite is high, the uplink and downlink frequency appear to drift due to the Doppler effect. As the satellite is moving towards your station, the downlink or uplink frequency appears to be higher, and is lower as the satellite is moving away. Therefore, you need to precisely adjust the uplink or downlink frequency to compensate for the frequency drift.

## Satellite operation

When your own signal can be received with a loop test, satellite communication can be performed.

1. Rotate **(MAIN DIAL)** to set the frequency.
2. When a frequency is shifted by the Doppler effect, rotate **(MAIN DIAL)** to tune to the frequency.
  - When you use beam antennas, you may need critical adjustment of the antenna direction, especially when communicating through satellites in low orbits.

### Using the RIT

You can tune the downlink frequency  $\pm 9.99$  kHz with the RIT. (p. 4-1)

#### Communicating in the FM mode:

- Some satellites require the transmit signal with a tone when communicating in the FM mode. Refer to amateur radio websites for more information.
- The AFC function automatically compensates for the frequency drift caused by the Doppler effect. (p. 7-2)

#### Communicating in the FM mode:

You can have a QSO with the crew of the ISS (International Space Station) using the Split function. Refer to related websites for more information.

## Satellite memories

The IC-9700 has 99 satellite memories to store both uplink and downlink frequencies, operating modes and other data.

- ① Tracking selection, normal or reverse, is not programmed in the satellite memories.
- ② Refer to the **ADVANCED MANUAL** for memory management details.

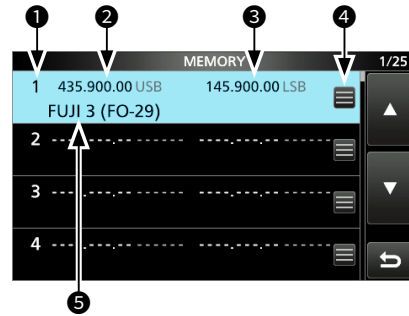

### ◇ Satellite memory screen

- ① Satellite memory number (1 ~ 99)
  - ② Downlink frequency  
The downlink frequency (Receive frequency) and mode.
  - ③ Uplink frequency  
The uplink frequency (Transmit frequency) and mode.
  - ④ Memory edit icon  
Touch to open the MEMORY menu. You can edit the memory name, write or clear the memory in the menu.
  - ⑤ Memory name  
The saved memory name is displayed.
- ③ Select a memory, then push [QUICK] to open the QUICK MENU. You can edit the memory name, write or clear the memory in the menu.

## Set mode description

You can use the Set mode to set infrequently changed values or function settings.

**TIP:** The Set mode is constructed in a tree structure. You may go to the next tree level, or go back a level, depending on the selected item.

1. Push **MENU**.

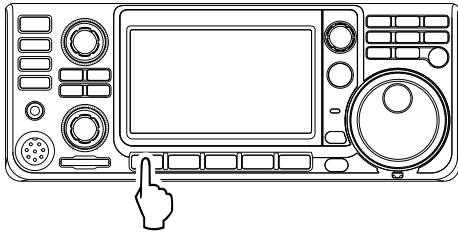

2. Touch **[SET]**.



3. Touch the category that you want to select.

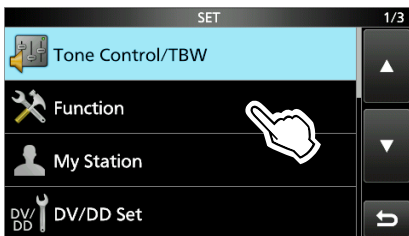

4. Push **[▲]** or **[▼]** to scroll through the items.  
 ① You can also rotate **ⓂMULTI** to scroll through the items.

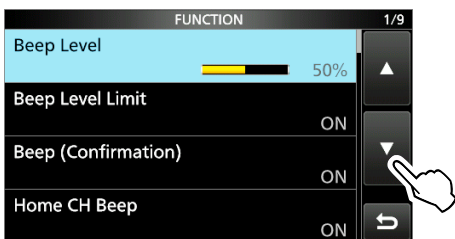

5. Touch the item to open the item's setting screen, or to open its next tree level.

① To go back to the previous tree level, push **EXIT**.

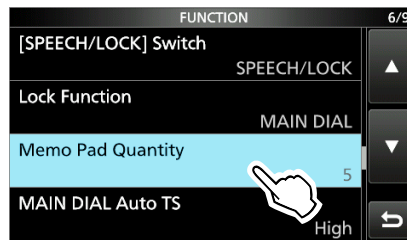

6. Touch to select or to set the option.  
 • The selected option is set, and returns to the previous screen.

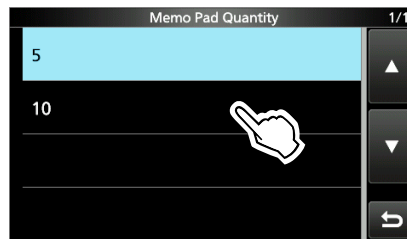

7. To close the SET screen, push **EXIT** several times.

### TIP: Resetting to the default setting

1. Push **QUICK** to display the QUICK MENU screen.
2. Touch "Default" to reset to the default setting.  
 ① To close the Quick menu, push **EXIT**.



## Tone Control/TBW

**MENU** » SET > Tone Control/TBW > **RX**

**SSB, AM, FM, DV, CW, RTTY**

**RX HPF/LPF** (Default: - - - - -)

Sets the cut-off frequencies for the receive audio high-pass filter and low-pass filter, in 100 Hz steps.

① If this item is set, the "RX Bass" and "RX Treble" items are automatically set to "0."

**SSB, AM, FM, DV**

**RX Bass** (Default: 0)

**RX Treble** (Default: 0)

Sets the bass or treble level of the receive audio.

**MENU** » SET > Tone Control/TBW > **TX**

**SSB, AM, FM, DV**

**TX Bass** (Default: 0)

**TX Treble** (Default: 0)

Sets the bass or treble level of the transmit audio.

**SSB**

**TBW (WIDE)** (Default: 100 – 2900)

**TBW (MID)** (Default: 300 – 2700)

**TBW (NAR)** (Default: 500 – 2500)

Sets the transmission passband width to wide, mid, or narrow, by changing the lower and higher cut-off frequencies.

**SSB-D**

**TBW** (Default: 300 – 2700)

Sets the transmission passband width by changing the lower and upper cut-off frequencies.

## Function

**MENU** » SET > **Function**

**Beep Level** (Default: 50%)

Sets the beep output level.

① If the "Beep (Confirmation)" item is set to "OFF," no beeps sound.

**Beep Level Limit** (Default: ON)

Selects whether or not to limit the volume up to the specified level.

- OFF: Does not limit the volume level.
- ON: Limits the volume level.

**Beep (Confirmation)** (Default: ON)

Turns the Confirmation beep ON or OFF.

- OFF: Turns the function OFF for silent operation.
- ON: A beep sounds when a switch is pushed or the touch panel is touched.

① If the "Beep Level" item is set to "0%," no beep sounds.

**Home CH Beep** (Default: ON)

Turns the Home CH Beep ON or OFF.

① In the VFO or Memory mode, when the Home Channel frequency or the Home Channel Memory is selected, the Home CH Beep sounds.

① In the DR screen, when the Home Channel Access repeater is set in FROM, the Home CH Beep sounds.

- OFF: No beep sounds.
- ON: Sounds a beep when you select the Home Channel.

**Band Edge Beep** (Default: ON (Default))

Selects an option for the Band Edge Beep function.

- OFF: Turns OFF the function.
- ON (Default): A beep sounds when you tune outside of, or back into the default amateur band's frequency range.
- ON (User): A beep sounds when you tune outside of, or back into a user programmed amateur band's frequency range.
- ON (User) & TX Limit: A beep sounds when you tune outside of, or back into a user programmed amateur band's frequency range. Transmitting is inhibited outside of the range.

① If the "Beep Level" item is set to "0%," no beep sounds.

**Beep Sound (MAIN)** (Default: 1000Hz)

**Beep Sound (SUB)** (Default: 1000Hz)

Sets the audio frequency for beeps.

① If the "Beep Level" item is set to "0%," no beep sounds.

Function (Continued)

**MENU** » SET > Function > **Sub Band Mute (TX)**

**Speaker/Phones** (Default: OFF)  
**USB** (Default: OFF)  
**LAN** (Default: OFF)

Selects whether or not to mute the received audio of the SUB band when you transmit.

- OFF: Does not mute the received audio of the SUB band.
- ON: Mutes the received audio of the SUB band.

**MENU** » SET > **Function**

**RF/SQL Control** (Default: RF+SQL)

Sets the **AF/RF/SQL** (outer) control operation.

- Auto: Functions as an RF gain control in the SSB, CW and RTTY modes. Functions as a squelch control in the AM, FM, DV, and DD modes.
- SQL: Functions as a squelch control in all modes. Does not function as an RF gain control.
- RF+SQL: Functions not only as an RF gain control, but also as a squelch control in all modes.

**When using as an RF gain/squelch control**

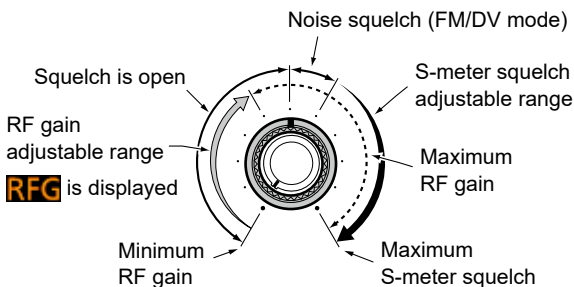

**When using as an RF gain control**  
 (Squelch is fixed open: SSB, CW, RTTY only)

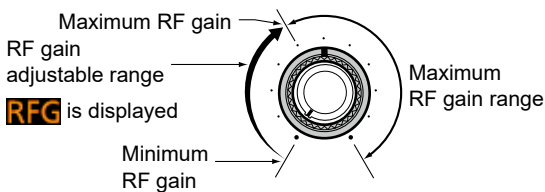

**When using as a squelch control**  
 (RF gain is fixed at maximum.)

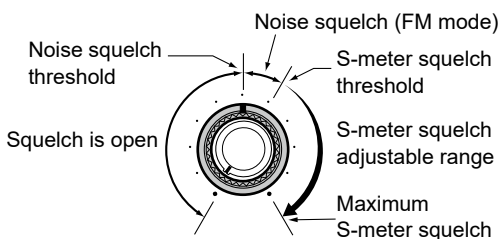

**FM/DV Center Error** (Default: ON)

Turns the FM/DV Center Error indication ON or OFF. The MAIN/SUB band indicator shows the received signal deviation.

When an off-center signal is received, the indicator blinks green.

- OFF: Turns OFF the function.
- ON: Turns ON the function.

**MENU** » SET > Function > **TX Delay**

**144M** (Default: OFF)  
**430M** (Default: OFF)  
**1200M** (Default: OFF)

Sets the TX delay time on the 144, 430, or 1200 MHz band.

- ① If an external equipment's rise time is slower than that of the IC-9700, a reflected wave is produced and it may damage the IC-9700 or the external device. To prevent this, set the appropriate delay time so that no reflected wave, or timing damage occurs.
- ① Select "OFF" for no rise speed.

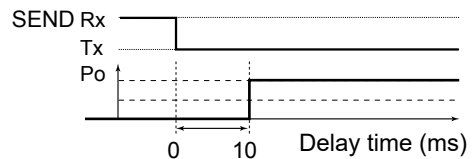

**MENU** » SET > **Function**

**Time-Out Timer** (Default: OFF)

Sets the Time-out Timer to OFF, 3, 5, 10, 20, or 30 minutes to prevent an accidental prolonged transmission.

- ① Select "OFF" for no time limit.

**PTT Lock** (Default: OFF)

Turns the PTT Lock function ON or OFF.

To prevent accidental transmissions, this function inhibits all transmissions.

- OFF: Turns OFF the function.
- ON: Inhibits all transmissions.

**MENU** » SET > Function > **SPLIT**

**Quick SPLIT** (Default: ON)

Turns the Quick SPLIT function ON or OFF.

This function automatically turns ON the SPLIT function, and set the frequency and mode that is not displayed (VFO A or AFO B), according to the SPLIT Offset setting.

- OFF: Turns OFF the function.
- ON: Turns ON the function.

**SPLIT Offset** (Default: 0.000 MHz)

Sets the SPLIT offset between -9.999 and +9.999 MHz. The SPLIT offset is the difference between the receive and transmit frequencies for the Quick SPLIT function.

**SPLIT LOCK** (Default: OFF)

Turns the Split Lock function ON or OFF. The SPLIT LOCK function enables you to adjust the transmit frequency while holding down **XFC**, even while the Dial Lock function is activated. To prevent accidentally changing the receive frequency by rotating **MAIN DIAL**, use both the SPLIT LOCK and Dial Lock functions (p. 3-10).

- OFF: Turns OFF the function.
- ON: Turns ON the function.

**MENU** » **SET > Function**

**Auto Repeater** (Default: ON)

The Auto repeater function automatically turns the duplex operation and tone encoder ON or OFF.

① This item is displayed only in the USA version.

- OFF: Turns OFF the function.
- ON (DUP): Turns ON the duplex settings only.
- ON (DUP, TONE): Turns ON the duplex settings and the tone encoder function.

**RTTY Mark Frequency** (Default: 2125)

Selects the RTTY mark frequency.

① When the internal RTTY decoder is used, 2125 Hz is automatically selected.

**RTTY Shift Width** (Default: 170)

Selects the RTTY shift width.

① When the internal RTTY decoder is used, 170 Hz is automatically selected.

**RTTY Keying Polarity** (Default: Normal)

Selects the RTTY keying polarity.

- Normal: Key open/close = Mark/Space
- Reverse: Key open/close = Space/Mark

**MENU** » **SET > Function > SPEECH**

**SPEECH Language** (Default: English)

Sets the speech language to English or Japanese.

**Alphabet** (Default: Normal)

Selects the alphabet characters announcement.

**SPEECH Speed** (Default: Fast)

Sets the speech speed to Fast or Slow.

**RX Call Sign SPEECH** (Default: ON (Kerchunk))

Turn the RX Call Sign Speech function ON or OFF for calls received in the DV mode.

**RX>CS SPEECH** (Default: ON)

Turn the RX>CS Speech function ON or OFF.

**S-Level SPEECH** (Default: ON)

Turns the S-meter level announcement ON or OFF.

- OFF: The operating mode and the operating frequency are announced when you push **SPEECH**.
- ON: The signal strength level, the operating mode and the operating frequency are announced when you push **SPEECH**.

**MODE SPEECH** (Default: OFF)

Turns the operating mode announcement ON or OFF.

- OFF: The selected operating mode is not announced.
- ON: The selected operating mode is announced.

**SPEECH Level** (Default: 50%)

Sets the Voice Synthesizer audio output level.

Function (Continued)

**MENU** » **SET > Function**

**[SPEECH/LOCK] Switch** (Default: SPEECH/LOCK)

Selects **[SPEECH/LOCK]** action.

- **SPEECH/LOCK:** Pushing **[SPEECH/LOCK]** turns ON the Voice Synthesizer function.  
Holding down **[SPEECH/LOCK]** turns the Lock function ON or OFF.
- **LOCK/SPEECH:** Pushing **[SPEECH/LOCK]** turns the Lock function ON or OFF.  
Holding down **[SPEECH/LOCK]** turns ON the Voice Synthesizer function.

**Lock Function** (Default: MAIN DIAL)

This function electronically locks **[MAIN DIAL]** or the panel display\* to prevent accidental changes.

\*Keys and dials are also locked except for **[AF>RF/SQL]**, **[AF>RF/SQL]**, **[POWER]**, and **[SPEECH/LOCK]**.

**Memo Pad Quantity** (Default: 5)

Sets the number of memo pad channels.

**MAIN DIAL Auto TS** (Default: High)

Sets the Auto Tuning Step function for **[MAIN DIAL]**. When rapidly rotating **[MAIN DIAL]**, the tuning step automatically changes according to the rotation speed.

- **OFF:** Auto tuning step is turned OFF.
- **Low:** Approximately two times faster.
- **High:** Approximately five times faster when the tuning step is set to 1 kHz or smaller.  
Approximately two times faster when the tuning step is set to 5 kHz or larger.

**MIC Up/Down Speed** (Default: Fast)

Selects the steps per second when changing an operating frequency by holding down the microphone's [UP]/[DN] key.

- **Slow:** Low speed (25 tuning steps/second)
- **Fast:** High speed (50 tuning steps/second)

**AFC Limit** (Default: ON)

Select whether to limit the operating range of the AFC (Automatic Frequency Control) function, or not.

- **OFF:** Turns OFF the function.
- **ON:** Limits the operating range of the AFC function. The limit value differs depending on the IF filter width as described below.

IF Filter width	AFC limit value
15 kHz	±10 kHz
10 kHz	±7 kHz
7 kHz	±5 kHz

**[NOTCH] Switch (SSB)** (Default: Auto/Manual)

**[NOTCH] Switch (AM)** (Default: Auto/Manual)

Selects the notch function used in the SSB or AM mode.

- **Auto:** Only the Auto Notch function can be used.
- **Manual:** Only the Manual Notch function can be used.
- **Auto/Manual:** Both the Auto and Manual Notch functions can be used.

**SSB/CW Synchronous Tuning** (Default: OFF)

Turns the Displayed Frequency Shift function ON or OFF.

This function automatically shifts the frequency to match the CW pitch when the operating mode is toggled between SSB and CW.

- **OFF:** Turns OFF the function.
- **ON:** When the operating mode is changed between SSB and CW, the operating frequency shifts by the offset amount.

**CW Normal Side** (Default: USB)

Selects the carrier point in the CW normal mode.

- **LSB:** Sets the carrier point to the LSB side.
- **USB:** Sets the carrier point to the USB side.

**MENU** » **SET > Function > Front Key Customize**

**[VOX/BK-IN]** (Default: VOX/BK-IN)

**[AUTOTUNE/AFC]** (Default: AUTOTUNE/AFC)

**[TONE/RX>CS]** (Default: TONE/RX>CS)

The function assignments for the **[VOX/BK-IN]**, **[AUTOTUNE/AFC]** / **[AFC]** and **[TONE/RX>CS]** keys on the front panel can be changed.

① See page 8-7 about the functions.

**MENU** » **SET > Function > MIC Key Customize**

**[UP]** (Default: UP (VFO: kHz))

**[DN]** (Default: DOWN (VFO: kHz))

The function assignments for the [UP] and [DN] keys on the microphone can be changed.

① See page 8-8 about the functions.

**MENU** » **SET > Function****Keyboard Type** (Default: Full Keyboard)

Sets the keyboard entry type to Ten-Key or Full Keyboard.

**Full Keyboard Layout** (Default: English)

Selects the on-screen keyboard layout between English, German and French.

**Screen Capture [POWER] Switch** (Default: OFF)

Assigns the Screen Capture function to **POWER**.

- OFF: **POWER** does not act as the Screen Capture key.
- ON: **POWER** acts as the Screen Capture key.

**Screen Capture File Type** (Default: PNG)

Sets the file format for the Screen Capture function to PNG or BMP.

**MENU** » **SET > Function > REF Adjust****REF Adjust**

Adjusts the internal reference frequency.

**REF Adjust (FINE)**

Fine tune the value set in "REF Adjust."

**NOTE:** The default setting of "REF Adjust" may differ slightly, depending on the transceiver's version.

**My Station****MENU** » **SET > My Station****My Call Sign (DV)**

The transceiver has a total of 6 memories to save your own call signs for DV mode.

You can enter a call sign of up to 8 digits. Also, a note of up to 4 characters, for operating transceiver type, area, and so on, can be entered.

**TX Message (DV)**

The transceiver has a total of 5 memories to save short messages for simultaneous transmission in the DV mode.

Enter a message of up to 20 alphanumeric characters for each memory.

① To transmit no message, select "OFF."

**My Call Sign (DD)**

The transceiver has a total of 6 memories to save your own call signs for DD mode.

You can enter a call sign of up to 8 digits. Also, a note of up to 4 characters, for operating transceiver type, area, and so on, can be entered.

## 8 SET MODE

### The assignable key functions for Front Key

●: Default setting    ○: Assignable    N/A: Not assignable

Function	Description	[VOX/BK-IN]	[AUTOTUNE/AFC]	[TONE/RX>CS]
VOX/BK-IN	<ul style="list-style-type: none"> <li>• Push to turn the VOX function in the Voice operation modes and the Break-in function in the CW mode ON or OFF.</li> <li>• Hold down for 1 second to open its function menu.</li> </ul>	●	N/A	N/A
AUTOTUNE/AFC	<p><b>In the CW mode</b> Push to automatically tune the operating frequency to a close-by CW signal.</p> <p><b>In the FM or DV mode</b> Push to turn the Auto Frequency Control function ON or OFF.</p>	N/A	●	○
AUTOTUNE/AFC/ RX>CS	<p><b>In the CW mode</b> Push to automatically tune the operating frequency to a close-by CW signal.</p> <p><b>In the FM, DV, or DD mode</b></p> <ul style="list-style-type: none"> <li>• In the FM or DV mode, push to turn the Auto Frequency Control function ON or OFF.</li> <li>• In the DV or DD mode, hold down for 1 second to display the RX History list.</li> </ul>	N/A	○	N/A
TONE/RX>CS	<p><b>In the FM mode</b></p> <ul style="list-style-type: none"> <li>• Push to display the Tone Set window.</li> <li>• Hold down for 1 second to display the TONE FREQUENCY window.</li> </ul> <p>① For European versions: While holding down [PTT], hold down this key to send the 1750 Hz tone.</p> <p><b>In the DV or DD mode</b></p> <ul style="list-style-type: none"> <li>• Push to display the RX History list.</li> <li>• Hold down for 1 second to capture the latest received call sign (station or repeater) as a temporary call destination.</li> </ul>	N/A	○	●
CD	Push to open the received call history.	○	○	N/A
CD/RX>CS	<ul style="list-style-type: none"> <li>• Push to open the received call history.</li> <li>• In the DV or DD mode, hold down for 1 second to display the RX History list.</li> </ul>	N/A	○	○
PRESET	Push to open the PRESET screen.	○	○	N/A
PRESET/ RX>CS	<ul style="list-style-type: none"> <li>• Push to open the PRESET screen.</li> <li>• In the DV or DD mode, hold down for 1 second to display the RX History list.</li> </ul>	N/A	○	○
Home CH	<p>Push to directly select the Home Channel that is set to the selected mode (VFO/Memory) or DR screen.</p> <p>① While in the Call channel mode, or when no Home CH is set, an error beep sounds.</p>	○	○	N/A
Home CH/ RX>CS	<ul style="list-style-type: none"> <li>• Push to directly select the Home Channel that is set to the selected mode (VFO/Memory) or DR screen.</li> </ul> <p>① While in the Call channel mode, or when no Home CH is set, this function is not activated.</p> <ul style="list-style-type: none"> <li>• In the DV or DD mode, hold down for 1 second to display the RX History list.</li> </ul>	N/A	○	○
Temporary Skip	Push to set the frequency to be skipped while scanning. The selected frequencies are temporarily skipped for faster scanning.	○	○	N/A
Temporary Skip/ RX>CS	<ul style="list-style-type: none"> <li>• Push to set the frequency to be skipped while scanning. The selected frequencies are temporarily skipped for faster scanning.</li> <li>• In the DV or DD mode, hold down for 1 second to display the RX History list.</li> </ul>	N/A	○	○
Voice/Keyer/RTTY Memory 1	<p><b>In the SSB, AM, FM, or DV mode</b></p> <ul style="list-style-type: none"> <li>• Push to transmit the voice audio recorded on the SD card once.</li> <li>• Hold down for 1 second to repeatedly transmit the voice audio.</li> </ul> <p>① This key function can also be used on the DR screen.</p>			
Voice/Keyer/RTTY Memory 2	<p>① If the voice audio is not saved in the Voice TX memory (T1 ~ T4), this function is disabled.</p> <p><b>In the CW mode</b></p>			
Voice/Keyer/RTTY Memory 3	<ul style="list-style-type: none"> <li>• Push to transmit the Keyer memory content once.</li> <li>• Hold down for 1 second to repeatedly transmit the memory content.</li> </ul> <p>① If the Keyer memory content (M1 ~ M4) is not entered, this function is disabled.</p>	○	○	N/A
Voice/Keyer/RTTY Memory 4	<p><b>In the RTTY mode</b></p> <p>Push to transmit the RTTY memory content once.</p> <p>① If the RTTY memory content (RT1 ~ RT4) is not entered, this function is disabled.</p>			

The assignable key functions for MIC Key

Function	Description
---	No function
UP	Push to increase the frequency (in 50 Hz steps*), Memory channel, repeater, or select the next station call sign. * When the Tuning Step function is ON, increases the frequency in the selected Tuning Step.
DOWN	Push to decrease the frequency (in 50 Hz steps*), Memory channel, repeater, or select the previous station call sign. * When the Tuning Step function is ON, increases the frequency in the selected Tuning Step.
UP (VFO: kHz)	Push to increase the frequency (in 1 kHz steps*), Memory channel, repeater, or select the next station call sign. * When the Tuning Step function is ON, increases the frequency in the selected Tuning Step.
DOWN (VFO: kHz)	Push to decrease the frequency (in 1 kHz steps*), Memory channel, repeater, or select the previous station call sign. * When the Tuning Step function is ON, increases the frequency in the selected Tuning Step.
XFC	While holding down the key, the transceiver monitors signals.
CALL	Push to select the Call channel mode.
VFO/MEMO	• Push to select the VFO mode and the Memory mode. • Hold down for 1 second to copy a Memory channel contents to the VFO.
DR	Push to turn the DR function ON or OFF.
FROM/TO (DR)	<b>In the DR screen</b> Push to select "FROM" or "TO."
Home CH	Push to directly select the Home Channel that is set to the selected mode (VFO/Memory) or DR screen. ① While in the Call channel mode, or when no Home CH is set, an error beep sounds.
BAND UP	<b>In the VFO or Memory mode</b> • Push to increase an operating band. • Hold down for 1 second to recall the Band Stacking Register contents.
BAND DOWN	<b>In the VFO or Memory mode</b> • Push to decrease an operating band. • Hold down for 1 second to recall the Band Stacking Register contents.
SCAN	• Push to start the previously selected scan. While scanning, push to stop the scan. • Hold down for 1 second to open the SCAN SELECT screen.
Temporary Skip	Push to set the frequency to be skipped while scanning. The selected frequencies are temporarily skipped for faster scanning.

Function	Description
SPEECH	Push to announce the frequency, operating mode, or call sign. ① In the VFO, Memory, or Call channel mode, the frequency and the operating mode are announced. ① In the DR screen, the call sign is announced. If Simplex is selected, the frequency is announced.
MAIN/DUAL	• Push to select the Main or Sub band. • Hold down for 1 second to turn the Dualwatch function ON or OFF.
MODE	• Push to select the operating mode. • Hold down to toggle USB and LSB, CW and CW-R, or RTTY and RTTY-R.
Voice/Keyer/RTTY Memory 1	<b>In the SSB, AM, FM, or DV mode</b> • Push to transmit the voice audio recorded on the SD card once. • Hold down for 1 second to repeatedly transmit the voice audio. ① This key function can also be used on the DR screen. ① If the voice audio is not saved in the Voice TX memory (T1 ~ T4), this function is disabled.
Voice/Keyer/RTTY Memory 2	<b>In the CW mode</b> • Push to transmit the Keyer memory content once. • Hold down for 1 second to repeatedly transmit the memory content. ① If the Keyer memory content (M1 ~ M4) is not entered, this function is disabled.
Voice/Keyer/RTTY Memory 3	<b>In the RTTY mode</b> Push to transmit the RTTY memory content once. ① If the RTTY memory content (RT1 ~ RT4) is not entered, this function is disabled.
Voice/Keyer/RTTY Memory 4	Push to transmit the RTTY memory content once. ① If the RTTY memory content (RT1 ~ RT4) is not entered, this function is disabled.
T-CALL	Push to transmit a 1750 Hz Tone. (Only for European version.)
RX>CS	<b>In the DV or DD mode</b> • Push to display the RX History list. • Hold down for 1 second to set the last calling station's call sign to "TO" (destination).
TS	• Push to turn the Tuning Step function ON or OFF. • Hold down for 1 second to open the TS screen.
MPAD	• Push to sequentially call up the contents in the Memo Pads. • Hold down for 1 second to save the displayed contents into the Memo Pad.
SPLIT	• Push to turn the Split function ON or OFF. • Hold down 1 second to turn ON the Quick Split function.
A/B	• Push to select the VFO A or VFO B. • Hold down for 1 second to set the displayed VFO's frequency to the VFO that is not displayed.

## DV/DD Set

**MENU** » **SET > DV/DD Set**

### Standby Beep (Default: ON (to me:Alarm/High Tone))

Turns the Standby Beep function ON or OFF.

This function sounds a beep after a received signal disappears, in the DV mode.

- OFF: Does not sound a beep after a received signal disappears.
- ON: Sounds a beep after a received signal disappears.
- ON (to me:High Tone):  
Sounds a high pitched beep when a received signal that is addressed to your call sign (MY) disappears.  
When any other received signal disappears, a regular beep sounds.
- ON (to me:Alarm/High Tone):  
Sounds alarm (PiRoPiRoPiRo) when a received signal that is addressed to your call sign (MY) disappears.  
When any other received signal disappears, a regular beep sounds.

① The standby beep sounds even when "Key-Touch Beep" is set to "OFF."

① The standby beep output level is depending on the Beep level setting.

### Auto Reply (Default: OFF)

Sets the Automatic Reply function to ON, OFF, or Voice. This function automatically replies to a call addressed to your own call sign, even if you are away from the transceiver.

- OFF: Turns OFF the function.
- ON: Replies with your own call sign. (No audio reply is sent)
- Voice: Replies with your call sign and any Auto Reply message recorded on the SD (up to 10 seconds).  
If no SD card is inserted, or no message is recorded, only your call sign is transmitted.  
The transmitted audio can be monitored.

① When "ON" or "Voice" is selected, the Automatic reply function is automatically turned OFF when you push **TRANSMIT** or microphone's [PTT].

### DV Data TX (Default: Auto)

Selects whether to manually or automatically transmit data in the DV mode.

- PTT: Push **TRANSMIT** or the microphone's [PTT] to manually transmit data.
- Auto: When data is input from a PC through the [DATA] jack, the transceiver automatically transmits it.

**MENU** » **SET > DV/DD Set > DV Fast Data**

### Fast Data (Default: OFF)

Selects whether or not to use the DV Fast Data function for data communication in the DV mode.

The DV Fast Data function uses the data and the audio frames to send data approximately 3.5 times faster than the normal speed. So, no audio can be sent.

- OFF: Sends data at the slow speed (approximately 950 bps).
- ON: Sends data at the fast speed (approximately 3480 bps).

① Even if "ON" is selected, when you push **TRANSMIT** or the microphone's [PTT], the data is sent at the slow speed, because the audio frame is used for the audio transmission.

The GPS data speed is set in "GPS Data Speed."

### GPS Data Speed (Default: Slow)

Sets the GPS data speed when the data is sent using the DV Fast Data function.

- Slow: Sends GPS data in the slow speed (approximately 950 bps).
- Fast: Sends GPS data in the fast speed (approximately 3480 bps).

① When you send the GPS data to other transceivers that can receive only slow speed data, set to "Slow."

### TX Delay (PTT) (Default: 2sec)

Sets the TX delay time.

In this setting, you can set the time for the transceiver sends the DV data using the DV Fast Data mode when you push **TRANSMIT** or hold down the microphone's [PTT].

- OFF: After pushing **TRANSMIT**, or releasing [PTT], the transceiver returns to receive.
- 1 ~ 10sec: After pushing **TRANSMIT**, or releasing [PTT], the transceiver sends data using the DV Fast Data mode for this set period. When the TX data is completely sent within this set period, the transceiver automatically returns to receive.

**NOTE:** This function is usable only when "DV Data TX" is set to "PTT."

**MENU** » **SET > DV/DD Set**

### Digital Monitor (Default: Auto)

Select a receive mode when **XFC** is pushed in the DV mode.

- Auto: Receives in the DV mode or the FM mode, depending on the received signal.
- Digital: Receives in the DV mode.
- Analog: Receives in the FM mode.

**MENU** » **SET > DV/DD Set****Digital Repeater Set** (Default: ON)

Turns the Digital Repeater Set function ON or OFF. When accessing a repeater that has a different call sign from the transceiver's current setting, this function can read the repeater's transmit signal and automatically enter the repeater's call signs into the transceiver.

- OFF: Turns OFF the function.
- ON: Automatically enters the repeater call sign.
- ON (GW): Automatically enters the repeater call sign.
  - ① The gateway repeater's call sign is automatically entered into R2.

**DV Auto Detect** (Default: OFF)

Turns the DV mode automatic detect function ON or OFF. When in the DV mode, if you receive a non-digital signal, this function automatically sets the operating mode to the FM mode.

- OFF: Turns the function OFF. The operating mode is fixed to the DV mode.
- ON: Automatically selects the FM mode for temporary operation.

**RX Record (RPT)** (Default: ALL)

The transceiver can record the data of up to 50 individual calls. When the received signal includes a status message ("UR?" or "RPT?") that is sent back from the access repeater, you can record up to 50 messages, or only the last call, in the Received Call Record.

- ALL: Records up to 50 calls.
- Latest Only: Records only the last call.

**BK** (Default: OFF)

The Break-in (BK) function enables you to break into a conversation, where the two other stations are communicating with call sign squelch enabled.

- OFF: Turns OFF the function.
- ON: Turns ON the function.
- ① The BK function is automatically turned OFF when transceiver is turned OFF.

**EMR** (Default: OFF)

The Enhanced Monitor Request (EMR) function enables all transceivers that receive an EMR signal automatically open their squelch to receive the signal.

- OFF: Turns OFF the function.
- ON: Turns ON the function.
- ① The EMR function is automatically turned OFF when transceiver is turned OFF.

**EMR AF Level** (Default: 50%)

Set the audio output level when an EMR communication mode signal is received. When an EMR signal is received, the audio will be heard at the programmed level, or the transceiver's audio level, whichever is higher. To disable the setting, set to "0."

**NOTE:** After an EMR signal disappears, the audio level will remain at the EMR level. In this case, rotate **(AF→RF/SQ)** to adjust the audio level.

**DD TX Inhibit (Power ON)** (Default: ON)

Select the TX INHIBIT setting when the transceiver is turned ON.

- OFF: Sets to OFF.
- ON: Sets to ON.

**DD Packet Output** (Default: Normal)

Sets the condition for outputting the packets in the DD mode.

- Normal: Outputs packets when:
  - A call addressed to your own call sign or a non-call sign specific call (CQCQCQ) are received.
  - An EMR signal is received.
  - A break-in call is received.
- All: Outputs all packets.

**DV Repeater Monitor Set****MENU** » **SET > DV Repeater Monitor Set****Connection IP Address List**

Selects the DV repeater's IP address list file to use when the DV Repeater Monitor function is turned ON. The files that is saved into the "IC-9700" > "RptMoni" folder on the SD card is displayed.

- ① If you do not use the file, select "Not Use."
- ① After changing the file name, select again.

## QSO/RX Log

**MENU** » **SET > QSO/RX Log**

### QSO Log (Default: OFF)

Selects whether or not to make a communication log on an SD card.

The communication log is made on an SD card, and saved in the "csv" format.

① This function requires an SD card (User supplied).

- OFF: The QSO Log function is OFF.
- ON: The transceiver makes a log on the SD card. The transceiver starts making a log when you begin talking.

#### TIP:

- The folder name is automatically created, as [IC-9700\QsoLog].
- The file name is automatically created, as shown in the example below:  
Log start date and time: 1st January 2019 15:30:00  
File name: 20190101\_153000.csv
- The log contents is not displayed on the transceiver.
- You can display the log contents on a PC.

### RX History Log (Default: OFF)

Selects whether or not to make a DV mode's receive history log on an SD card.

The receive history log is made on an SD card, and saved in the "csv" format.

① This function requires an SD card (User supplied).

- OFF: The RX History Log function is OFF.
- ON: The transceiver makes a DV mode's receive history log on the SD card. The transceiver starts making a receive history log when you finish talking.

#### TIP:

- The folder name is automatically created, as [IC-9700\RxLog].
- The file name is automatically created, as shown in the example below:  
Log start date and time: 1st January 2019 15:30:00  
File name: 20190101\_153000.csv
- The log contents is not displayed on the transceiver.
- You can display the log contents on a PC.

**MENU** » **SET > QSO/RX Log > CSV Format**

### Separator/Decimal (Default: Sep [,] Dec [.]\*)

Select the separator and the decimal character for the CSV format.

- Sep [,] Dec [.]: Separator is "," and Decimal is "."
  - Sep [;] Dec [.]: Separator is ";" and Decimal is "."
  - Sep [;] Dec [,]: Separator is ";" and Decimal is ","
- \* The default value may differ, depending on the transceiver version.

### Date (Default: mm/dd/yyyy\*)

Select the date format between "yyyy/mm/dd," "mm/dd/yyyy" and "dd/mm/yyyy." (y: year, m: month, d: day)

\* The default value may differ, depending on the transceiver version.

The call log contents are shown below:

Contents	Example		Descriptions
Type	RF	RF	How the signal is transmitted or received (RF: The Normal mode (RF), TM: The Terminal mode, MONI: The DV Repeater Monitor function)
TX/RX	TX	RX	Transmission and reception
Date	1/1/2019 13:51:48	1/1/2019 13:51:48	Date and time the call was started.
Main Frequency	438.010000	438.010000	Operating frequency of the MAIN band
Main Mode	DV	DV	Operating mode of the MAIN band (USB/USB-D/LSB/LSB-D/CW/CW-R/RTTY/RTTY-R/AM/AM-D/FM/FM-D/DV/DD)
SUB Frequency	438.010000	438.010000	Operating frequency of the SUB band
SUB Mode	DV	DV	Operating mode of the SUB band (USB/USB-D/LSB/LSB-D/CW/CW-R/RTTY/RTTY-R/AM/AM-D/FM/FM-D/DV/DD)
My Latitude	34.764667	34.764667	Your latitude (unit: degree) (+: North latitude, -: South latitude)
My Longitude	135.375333	135.375333	Your longitude (unit: degree) (+: East longitude, -: West longitude)
My Altitude	50.5	50.5	Your altitude (unit: m) Records to one decimal place.
RPT Call Sign	JP3YHJ	JP3YHJ A	Repeater call sign (DV mode only)
TX Call Sign	CQCQCQ	(Blank)	TX Call sign (DV mode only)
RX Call Sign	(Blank)	JA3YUAA/9700	RX Call sign (DV mode only)
Main RF Power	20%	(Blank)	TX output power level
Main S meter	(Blank)	S0	The relative signal strength of the receive signal (in 16 levels)
SUB RF Power	20%	(Blank)	TX output power level
SUB S meter	(Blank)	S0	The relative signal strength of the receive signal (in 16 levels)
RX Latitude	(Blank)	34.764667	Caller's latitude, if sent. (unit: degree) (+: North latitude, -: South latitude) Records only when you receive in the DV mode.
RX Longitude	(Blank)	135.375333	Caller's longitude, if sent. (unit: degree) (+: East longitude, -: West longitude) Records only when you receive in the DV mode.
RX Altitude	(Blank)	30.5	Caller's altitude, if sent. (unit: m) Records only when you receive in the DV mode.

## QSO/RX Log (Continued)

The RX log contents are shown below:

Contents	Example	Descriptions
Type	RF	How the signal is received (RF: The Normal mode (RF), TM: The Terminal mode, MONI: The DV Repeater Monitor function)
Frequency	438.010000	RX Frequency
Mode	DV	Operating mode (DV mode is fixed)
Caller	JA3YUAA	Call sign of the caller station (up to 8 characters)
/	9700	Note after the call sign (up to 4 characters)
Called	CQCQCQ	Call sign of the called station
Rx RPT1	JP3YHH G	Access repeater call sign of the caller station or the gateway repeater call sign of your local area repeater.
Rx RPT2	JP3YHJA	Access repeater call sign of the called station
Message	Hello CQ D-STAR!	Message included in the received call (up to 20 characters)
Status	(Blank)	Normal: blank, Uplink: "RPT UP", Access repeater reply: "UR?" or "RPT?"
Received date	1/1/2019 13:51:48	Date and time the call was received Depending on the setting, the format may differ.
BK	*	BK call: "**", Normal call: Blank
EMR	*	EMR call: "**", Normal call: Blank
Latitude	34.764667	Caller's latitude, if sent. (unit: degree) (+: North latitude, -: South latitude)
Longitude	135.375333	Caller's longitude, if sent. (unit: degree) (+: East longitude, -: West longitude)
Altitude	30.5	Caller's altitude, if sent. (unit: m) Records to one decimal place.
SSID	-A	Caller's SSID, if sent. (0, -1 to -15, -A to -Z)
D-PRS Symbol	Car	Icon: Converts to text, None: Code
Course	123	Caller's course (unit: degree)
Speed	23.5	Caller's speed (unit: km/h) Records to one decimal place.
Power	49	TX power (unit: W)
Height	24	Antenna height (unit: m)
Gain	6	Antenna gain (unit: dB)
Directivity	Omni	Antenna directivity (Omni, 45, 90, 135, 180, 225, 270, 315 or 360)
Object/Item Name	HAM FES	Object name or Item name (up to 9 characters)
Data Type	Live Object	Data type of Object or Item (Live or Kill)
Temperature	20.5	Temperature (unit: °C) Records to one decimal place.
Rainfall	253.7	Rainfall (unit: mm) Records to one decimal place.
Rainfall (24 Hours)	253.7	Rainfall (24 Hours) (unit: mm) Records to one decimal place.
Rainfall (Midnight)	253.7	Rainfall (Midnight) (unit: mm) Records to one decimal place.
Wind Direction	315	Wind Direction (unit: degree)
Wind Speed	10.0	Wind Speed (unit: m/s) Records to one decimal place.
Gust Speed	10.0	Gust Speed (unit: m/s) Records to one decimal place.
Barometric	1013.0	Barometric (unit: hPa) Records to one decimal place.
Humidity	85	Humidity (unit: %)
GPS Time Stamp	12:00:00	Time data that the caller station acquires the position data
GPS Message	Osaka City/IC-9700	Caller is "NMEA": Records the GPS message Caller is "D-PRS": Records the D-PRS comment

## Connectors

**MENU** » SET > Connectors > **External P.AMP**

**144M** (Default: OFF)  
**430M** (Default: OFF)  
**1200M** (Default: OFF)

Selects whether or not to use an external preamplifier, for each band.

The preamplifiers amplify received signals to improve the S/N ratio and sensitivity.

- OFF: Does not use an external preamplifier.
- ON: Uses an external preamplifier.

**MENU** » SET > **Connectors**

**External Speaker Separate** (Default: Separate)

Sets the audio output when the external speaker is connected.

- Separate: The MAIN band audio is output from the [EXT-SP MAIN] jack, and the SUB band audio is output from the [EXT-SP SUB] jack.
- Mix: Mix and output the audio of the MAIN band and SUB band.

**MENU** » SET > Connectors > **Phones**

**Level** (Default: 0)

Sets the audio output level ratio of the headphone and internal speaker between -15 and +15.

**L/R Mix** (Default: Auto)

Sets the audio output when the headphone is connected.

- Separate: The MAIN band audio is output from the left side, and the SUB band audio is output from the right side.
- Mix: Mix and output the audio of the MAIN band and SUB band.
- Auto: **When the SUB band is displayed:**  
The MAIN band audio is output from the left side, and the SUB band audio is output from the right side.  
**When the SUB band is not displayed:**  
The MAIN band audio is output from the left and right side.

**MENU** » SET > Connectors > **ACC AF/IF Output**

**AF/SQL Output Select** (Default: MAIN)

Selects the audio and squelch signals to output from the [ACC] (DIN 8-pin) socket in the MAIN/SUB bands.

- MAIN: Outputs the audio and squelch signals of the MAIN band.
- SUB: Outputs the audio and squelch signals of the SUB band.

**Output Select** (Default: AF)

Selects the signal output from [ACC].

- AF: An AF signal is output.
- IF: A 12 kHz IF signal is output.

**AF Output Level** (Default: 50%)

Sets the AF output level of [ACC], when "Output Select" of ACC is set to "AF."

**AF SQL** (Default: OFF (Open))

Selects whether or not to output the audio from [ACC], according to the squelch state, when "Output Select" of ACC is set to "AF."

- OFF (Open): The squelch is always opened regardless of the transceiver's squelch level.
- ON: The squelch opens and closes, according to the transceiver's squelch level.

**AF Beep/Speech... Output** (Default: OFF)

Sets the Beep and Speech audio output setting of [ACC], when "Output Select" of ACC is set to "AF."

- OFF: The beep and speech audio are not output.
- ON: The beep and speech audio are output.

**IF Output Level** (Default: 50%)

Sets the IF output level of [ACC], when "Output Select" of ACC is set to "IF."

**Connectors (Continued)**

**MENU** » SET > Connectors > **USB AF/IF Output**

**Output Select** (Default: AF)

Selects the signal output from [USB].

- AF: An AF signal is output.
- IF: A 12 kHz IF signal is output.

**AF Output Level** (Default: 50%)

Sets the AF output level of [USB], when "Output Select" of USB is set to "AF."

**AF SQL** (Default: OFF (Open))

Selects whether or not to output the audio from [USB], according to the squelch state, when "Output Select" of USB is set to "AF."

- OFF (Open): The squelch is always opened regardless of the transceiver's squelch level.
- ON: The squelch opens and closes, according to the transceiver's squelch level.

**AF Beep/Speech... Output** (Default: OFF)

Sets the Beep and Speech audio output setting of [USB], when "Output Select" of USB is set to "AF."

- OFF: The beep and speech audio are not output.
- ON: The beep and speech audio are output.

**IF Output Level** (Default: 50%)

Sets the IF output level of [USB], when "Output Select" of USB is set to "IF."

**MENU** » SET > Connectors > **LAN AF/IF Output**

**Output Select** (Default: AF)

Selects the signal output from [LAN].

- AF: An AF signal is output.
- IF: A 12 kHz IF signal is output.

**AF SQL** (Default: ON)

Selects whether or not to output the audio from [LAN], according to the squelch state, when "Output Select" of LAN is set to "AF."

- OFF (Open): The squelch is always opened regardless of the transceiver's squelch level.
- ON: The squelch opens and closes, according to the transceiver's squelch level.

**MENU** » SET > Connectors > **MOD Input**

- ACC MOD Level** (Default: 50%)
- USB MOD Level** (Default: 50%)
- LAN MOD Level** (Default: 50%)

Sets the modulation input level of each interface.

**DATA OFF MOD** (Default: MIC,ACC)  
**DATA MOD** (Default: ACC)

In the SSB, AM, or FM mode, selects the connector(s) to input the modulation signal when the data mode is OFF, or ON.

**MENU** » SET > Connectors > **ACC SEND Output**

- 144M** (Default: ON)
- 430M** (Default: ON)
- 1200M** (Default: ON)

Selects whether or not to switch the SEND terminal output level of [ACC] to the Low level during transmitting.

- OFF: Does not switch to the Low level.
- ON: Switches to the Low level.

**MENU** » SET > Connectors > **USB SEND/Keying**

**TIP:**

This is the setting for the terminal used for data communication when you operate the transceiver from the software on the PC. When you connect the transceiver to a PC with a USB cable, 2 COM ports are recognized on the PC. To confirm USB (A)/USB (B), open the COM port properties, and confirm the "Value" of the "Details" tab.

**USB SEND** (Default: OFF)

Sets the USB terminal of the transceiver to receive the SEND signal from the software on the PC.

Select the same terminal as the terminal set by the software.

- ① You cannot select the terminal which is already selected in the "USB Keying (CW)" or "USB Keying (RTTY)" item.

**USB Keying (CW)** (Default: OFF)

Sets the USB terminal of the transceiver to receive the CW Keying signal from the software on the PC.

Select the same terminal as the terminal set by the software.

- ① You cannot select the terminal which is already selected in the "USB SEND" or "USB Keying (RTTY)" item.

**USB Keying (RTTY)** (Default: OFF)

Sets the USB terminal of the transceiver to receive the RTTY Keying signal from the software on the PC.

Select the same terminal as the terminal set by the software.

- ① You cannot select the terminal which is already selected in the "USB SEND" or "USB Keying (CW)" item.

**MENU** » SET > Connectors > **USB SEND/Keying**

**Inhibit Timer at USB Connection** (Default: ON)

Sets to prevent unintentional SEND or Keying signal transmission, under the following conditions.

- When connecting a PC to the transceiver using a USB cable.
  - While the transceiver and a PC are connected using a USB cable, or when starting up the PC or connecting or disconnecting a USB device to or from the PC.
  - When a virtual serial port communication has been established.
- OFF: The transceiver transmits the SEND or Keying signal right after a PC or USB device is connected.
  - ON: The transceiver transmits after a few seconds have passed, to prevent unintentional transmission.

①If you change this setting to "OFF," update the transceiver's USB driver and make sure the SEND or Keying signal will not be unintentionally transmitted.

**MENU** » SET > Connectors > **External Keypad**

**VOICE** (Default: OFF)  
**KEYER** (Default: OFF)  
**RTTY** (Default: OFF)

Enables each memory (voice, keyer, RTTY) transmission using an external keypad.

**MENU** » SET > Connectors > **CI-V**

**CI-V Baud Rate** (Default: Auto)

Selects the CI-V data transfer rate.

①When "Auto" is selected, the baud rate is automatically set according to the data rate of the connected device.

**CI-V Address** (Default: A2h)

Sets the CI-V address.

①"A2h" is the default address of the IC-9700.

**CI-V Transceive** (Default: ON)

Turns the Transceive function ON or OFF.

- OFF: The status is not output.
- ON: The status is output.  
 When you change a setting on the transceiver, the same change is automatically set on other connected transceivers or receivers, and vice versa.

**USB/LAN→REMOTE Transceive Address**

(Default: 00h)

Sets the address used to remotely control the transceiver or the receiver, through the [USB] port or the [LAN] port.

The external equipment control signal is output from the [REMOTE] jack.

**CI-V USB Port** (Default: Unlink from [REMOTE])

Selects the internal connection type between the [USB] and [REMOTE] CI-V ports.

- Link to [REMOTE]:  
 The [USB] and [REMOTE] CI-V ports are internally connected.
- Unlink from [REMOTE]:  
 The [USB] and [REMOTE] CI-V ports are not internally connected.  
 Each port functions independently.

**CI-V USB Baud Rate** (Default: Auto)

Selects the CI-V data transfer rate when remotely controlling the IC-9700 through the [USB] CI-V port.

①When "Auto" is selected, the baud rate is automatically set according to the data rate of the external device.

①This setting is valid only when the "CI-V USB Port" item is set to "Unlink from [REMOTE]."

**CI-V USB Echo Back** (Default: OFF)

Turns the Data Echo Back function ON or OFF, when remotely controlling the IC-9700 through the [USB] CI-V port.

①This setting is valid only when the "CI-V USB Port" item is set to "Unlink from [REMOTE]."

**CI-V DATA Baud Rate** (Default: OFF)

Selects the CI-V data transfer rate when remotely controlling the IC-9700 through the [DATA] jack.

**CI-V DATA Echo Back** (Default: OFF)

Turns the Data Echo Back function ON or OFF, when remotely controlling the IC-9700 through the [DATA] jack.

## Connectors (Continued)

**MENU** » **SET > Connectors > USB (B)/DATA Function**

### **USB (B) Function** (Default: OFF)

The transceiver has 2 virtual COM ports, A and B. When connecting to a USB port on your PC, the ports are virtually named as USB (A) and USB (B).

In this item, sets the function to be assigned to USB (B).

USB (A) is used for programming, or CI-V operation.

- OFF: Does not assign the function to USB (B).
- RTTY Decode: Outputs the decoded data of the RTTY signal.
- DV Data: Inputs or outputs low speed data for the DV mode.

### **DATA Function** (Default: GPS/Weather)

Sets the function to be assigned to the [DATA] jack.

- OFF: Does not assign the function to the [DATA] jack.
- RTTY Decode: Outputs the decoded data of the RTTY signal.
- DV Data: Inputs or outputs low speed data for the DV mode.
- GPS/Weather: Selected when connecting a GPS receiver.
- CI-V: Inputs or outputs CI-V commands.

### **GPS Out** (Default: OFF)

Selects whether or not to output the position data to USB (B) when the GPS receiver is connected to the [DATA] jack.

- OFF: Does not output the position data to USB (B).
- DATA→USB (B): Outputs the position data to USB (B).

① It is valid when "USB (B) Function" is set to "OFF" or "DV Data," and "DATA Function" is set to "GPS/Weather."

### **DV Data/GPS Out Baud Rate** (Default: 9600)

Sets the transfer rate of the DV data and the GPS output data.

### **RTTY Decode Baud Rate** (Default: 9600)

Set the data transfer rate of the RTTY decoded signals.

**MENU** » **SET > Connectors**

### **PTT Port Function** (Default: PTT Input + SEND Output)

Set the behavior of the PTT pin on the [MIC] connector.

- PTT Input: While transmitting, the transceiver does not output the SEND signal (TX status) from the PTT pin, but does detect the PTT input (PTT operation) on the microphone.
- PTT Input + SEND Output: While transmitting using other than the operating microphone, the transceiver does not detect the PTT input (PTT operation) of the microphone, due to the output SEND signal from the PTT pin.

**NOTE:** If you want to do the following operations, set to "PTT Input."

- Transmit voice audio by holding down [PTT] on the microphone while transmitting an image in the DV Fast Data mode.
- Cancel transmitting the recorded audio by pushing [PTT] on the microphone.

## Network

**MENU** » **SET > Network**

### DHCP (Valid after Restart) (Default: ON)

Turns the DHCP function ON or OFF.

- OFF: Uses a static IP address.
- ON: Uses the DHCP function.  
If a DHCP server is in your network environment, the IP address is automatically obtained.

### IP Address (Valid after Restart) (Default: 192.168.0.10)

Sets the static IP address.

### Subnet Mask (Valid after Restart) (Default: 255.255.255.0 (24 bit))

Sets the subnet mask to connect to your PC or LAN (Local Area Network), through the Ethernet.

### Default Gateway (Valid after Restart) (Default: . . . .)

Sets the Default Gateway of the IC-9700. When you remotely control the IC-9700, a Default Gateway setting is required.

### Primary DNS Server (Valid after Restart) (Default: . . . .)

Sets the Primary DNS Server address.

### 2nd DNS Server (Valid after Restart) (Default: . . . .)

If there are two DNS server addresses, sets the secondary DNS server address.

### Network Name

If you are operating the IC-9700 using the optional RS-BA1, enter a network name of up to 15 characters.

### Network Control (Valid after Restart) (Default: OFF)

Selects whether or not to remotely control the IC-9700.

- OFF: Disables remote control of the IC-9700.
- ON: Enables remote control of the IC-9700.

### Power OFF Setting (for Remote Control) (Default: Shutdown only)

Selects whether or not to display the Standby/Shutdown option dialog after holding down **POWER** for 1 second.

- Shutdown only: Shut down the IC-9700 when you turn it OFF.
- Standby/Shutdown: Displays the Standby/Shutdown option dialog when you turn it OFF.

**MENU** » **SET > Network**

### Control Port (UDP) (Valid after Restart) (Default: 50001)

Sets a port number for the control signal transfers between the IC-9700 and the remote station, when you remotely control the IC-9700.

### Serial Port (UDP) (Valid after Restart) (Default: 50002)

Sets a port number for the serial data transfers between the IC-9700 and the remote station, when you remotely control the IC-9700.

### Audio Port (UDP) (Valid after Restart) (Default: 50003)

Sets a port number for the audio signal transfers between the IC-9700 and the remote station, when you remotely control the IC-9700.

### Internet Access Line (Valid after Restart) (Default: FTTH)

Selects the Internet access line setting for the IP remote control.

**MENU** » **SET > Network > Network User1**

**MENU** » **SET > Network > Network User2**

### Network User1 ID

### Network User2 ID

Sets a user name of up to 16 characters, when you remotely control the IC-9700.

### Network User1 Password

### Network User2 Password

Sets a user password.

- ① The password must include a minimum of 8 characters and a maximum of 16 characters.
- ① You cannot use a password that consists of the same characters.

### Network User1 ID Administrator (Default: NO)

### Network User2 ID Administrator (Default: NO)

Selects whether or not to set the user as the administrator.

Only the authorized user can disconnect the communication between the IC-9700 and the remote station.

**MENU** » **SET > Network**

### Network Radio Name (Default: IC-9700)

Sets the IC-9700's name of up to 16 characters that is displayed in the remote control software, when you remotely control the IC-9700.

## Display

**MENU** » **SET > Display**

### LCD Backlight (Default: 50%)

Sets the LCD backlight brightness.

### Display Type (Default: A)

Sets the display type to A or B.

### Display Font (Default: Basic)

Selects the font for the frequency readout.

### Meter Peak Hold (Default: ON)

Turns the Meter Peak Hold function ON or OFF.

### Memory Name (Default: ON)

Turns the Memory name display in the Memory mode ON or OFF.

### MN-Q Popup (MN OFF→ON) (Default: ON)

Turns the Manual Notch filter width display ON or OFF.

### BW Popup (PBT) (Default: ON)

Selects whether or not to display the PBT shift value during PBT operation with **(MULTI)**.

### BW Popup (FIL) (Default: ON)

Selects whether or not to display the IF filter width and shift value when you switch the IF filter.

### RX Call Sign Display (Default: Normal)

In the DV mode, selects whether or not to display the call sign and the message of the caller station, when a call is received.

- OFF: Does not display the caller station's call sign and message.
- Normal: The caller station's call sign and message automatically scroll once, and then disappear.
- RX Hold: The caller station's call sign and message automatically scroll once, and then the call sign is displayed on the transceiver's display until the signal disappears.
- Hold: The caller station's call sign and message automatically scroll once, and then the call sign is displayed on the transceiver's display until the signal disappears. When the signal disappears, the call sign and the message are each repeatedly displayed for 2 seconds.

①When "Normal," "RX Hold," or "Hold" is selected, and if the call sign and name of the caller station is programmed in your memory, the programmed name is displayed after showing the call sign.

### RX Position Indicator (Default: ON)

Selects whether or not to display the indicator when the position data is included in the signal received in the DV mode.

- OFF: No indicator is displayed even though the position data is included in the received signal.
  - ON: The indicator is displayed when the position data is included in the received signal.
- ①When "RX Call Sign Display" is set to "OFF," the indicator is not displayed even though position data is included in the received signal.

### RX Position Display (Default: ON (Main/Sub))

Selects whether or not to display in a dialog when the caller station's position data is included in the signal received in the DV mode.

- OFF: No data is displayed in a dialog.
- ON (Main/Sub):  
When the caller station's position data is included in the signal, its data is displayed in a dialog.
- ON (Main Only):  
When the caller station's position data is included in the signal received in the MAIN band, its data is displayed in a dialog.

①The time period to display the dialog depends on the "RX Position Display Timer" setting.

### RX Position Display Timer (Default: 10sec)

Sets the RX position data's time period to display in the dialog.

- 5/10/15/30sec: Displays the caller's position for this set period of time.
- Hold: Displays the caller's position until you operate the transceiver.

### Reply Position Display (Default: ON)

Selects whether or not to display the caller's position data when the data is included in the Auto Replay signal.

- OFF: Does not display the caller's position data.
- ON: Automatically displays the caller's position data.

### RX Picture Indicator (Default: ON)

Select whether or not to display the RX Picture Indicator when a picture is included in the received signal.

- OFF: No indicator is displayed, even if a picture is included in the received signal.
- ON: The indicator is displayed when a picture is included in the received signal.

①When "RX Call Sign Display" is set to "OFF," the indicator is not displayed, even if the picture is included in the received signal.

**TX Call Sign Display** (Default: Your Call Sign)

Select whether or not to display My or Your call sign while transmitting.

- OFF: Turns the function OFF.
  - Your Call Sign: Displays and scrolls the call sign of the target station.
  - My Call Sign: Displays and scrolls your own call sign.
- ① When "Your Call Sign" is selected, and if the call sign and name of the caller station is programmed in your memory, the programmed name is displayed after the call sign.

**Scroll Speed** (Default: Fast)

Set the scrolling speed of the message, call sign, or other text, that are displayed on the transceiver's LCD to "Slow" or "Fast."

**Screen Saver** (Default: 60min)

Sets the Screen Saver function. This function activates and automatically turns OFF the screen when no operation is performed for the preset period of time.

**Opening Message** (Default: ON)

Selects whether or not to display the opening message at power ON.

**Power ON Check** (Default: ON)

Selects whether or not to display the RF Power level at power ON.

**MENU** » **SET > Display > Display Unit**

① The default values of "Display Unit" settings may differ, depending on the transceiver version.

**Latitude/Longitude** (Default: ddd° mm.mm')

Selects the format to display the position.

**Altitude/Distance** (Default: m)

Select the format to display the distance and elevation.

**Speed** (Default: km/h)

Select the format to display the speed.

**Temperature** (Default: °C)

Select the format to display the temperature.

**Barometric** (Default: hPa)

Select the format to display the barometric pressure.

**Rainfall** (Default: mm)

Select the format to display the amount of rainfall.

**Wind Speed** (Default: mph)

Select the format to display the wind speed.

**MENU** » **SET > Display****Display Language** (Default: English)

Set the screen display language type to English or Japanese.

① This item is displayed only when the "System Language" is set to "Japanese."

**System Language** (Default: English)

Set the system language of the transceiver.

- English: The system language of the transceiver is English. Only alphabetical characters (A to Z, a to z, 0 to 9) and symbols (! " # \$ % & ' ( ) \* + , - . / : ; < = > ? @ [ \ ] ^ \_ ` { | } ~) can be displayed. If Japanese characters (Kanji, Hiragana and Katakana) are included, the display shows "=" or "\_" instead of that character. In that case, you can only delete "=" or "\_" in the transceiver's edit mode.
  - Japanese: The system language of the transceiver is Japanese. Kanji, Hiragana and Katakana characters, and the 2-bytes symbols can be displayed. To display such characters in the DR screen or Menu mode, set "Display Language" to "Japanese."
- ① When this item is set to "English," "Display Language" is not displayed.

When you set the system language of the transceiver to Japanese, the IC-9700 has the capability to display both English and Japanese characters. HOWEVER, if you select Japanese, all menu items throughout the IC-9700 system will be displayed in only Japanese characters. There will be no English item names. Unless you are fluent in reading Japanese characters, use this feature with extreme caution.

If you have change the IC-9700's language to Japanese, and do not understand the menu system in the new setting, you will have to change the language back to English by doing a partial reset of the IC-9700 CPU. A partial reset will not clear your call sign databases.

To do a partial reset of the CPU, do the following steps:

1. Push [MENU].
2. Touch <SET>.
3. Touch the item (with the "etc" icon) shown below.



4. Touch the bottom item shown below.

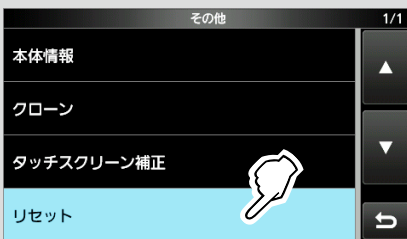

5. Touch the upper item shown below.

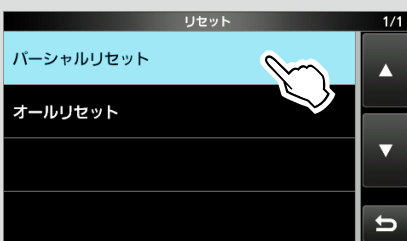

6. The dialog is displayed as shown below. Touch the left item.

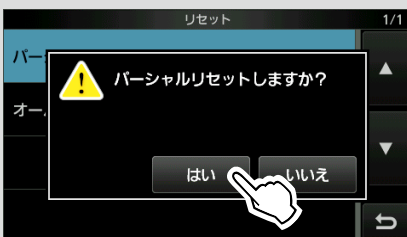

The transceiver displays "PARTIAL RESET," then the partial reset is completed.

## Time Set

[MENU] » [SET > Time Set > Date/Time]

### Date

Sets the date (Year/Month/Day).

① The day of the week is automatically set.

### Time

Sets the current time.

① The time is displayed in the 24 hour format.

**NOTE: The backup battery for the internal clock**  
 The IC-9700 has a rechargeable Lithium battery to backup the internal clock. If you connect the transceiver to a power source, the battery is charged and it keeps the correct clock setting. However, if you do not connect the transceiver to a power source for a long period of time, the battery will discharge. In that case, the transceiver resets the internal clock.  
 If you do not use the transceiver for a long period of time, we recommend that you connect the transceiver to a power source at least once a month. The charging period is two days whether the transceiver's power is ON or OFF.

### <<NTP TIME SYNC>>

Synchronizes the internal clock with the time management server.

① To use this function, you need an Internet connection and default gateway settings.

### NTP Function (Default: ON)

Automatically obtains the current time from the NTP server.

### NTP Server Address (Default: time.nist.gov)

Sets NTP server address.

### GPS Time Correct (Default: Auto)

Select whether or not the time data is automatically corrected by a received GPS sentence.

[MENU] » [SET > Time Set]

### UTC Offset (Default: ± 0:00)

Sets the UTC offset time.

## SD Card

**MENU** » **SET > SD Card**

### Load Setting

Selects the saved data file to load.

### Save Setting

Saves the setting data onto an SD card.

### Save Form (Default: Now Ver)

Selects the format to save the settings to an SD card.

- Now Ver: Saves the settings in the current version format.
- Old Ver (x.xx - x.xx): Saves the settings in an older version format indicated in the parenthesis (x.xx = version).

① If you select "Old Ver (x.xx - x.xx)," a function that is added when the transceiver's firmware format is updated will not be saved.

② You cannot load a setting file that is saved in the current version format to an earlier firmware version.

**MENU** » **SET > SD Card > Import/Export**

### Import

Import the UR call sign, repeater list or GPS memory data in the CSV format file.

### Export

Export the UR call sign, repeater list or GPS memory data in the CSV format file.

**MENU** » **SET > SD Card > Import/Export > CSV Format**

### Separator/Decimal (Default: Sep [,] Dec [.]\*)

Select the separator and the decimal character for the CSV format.

- Sep [,] Dec [.]: Separator is "," and Decimal is "."
- Sep [.] Dec [,]: Separator is "." and Decimal is ","
- Sep [;] Dec [,]: Separator is ";" and Decimal is ","

\* The default value may differ, depending on the transceiver version.

### Date (Default: mm/dd/yyyy\*)

Select the date format between "yyyy/mm/dd," "mm/dd/yyyy" and "dd/mm/yyyy." (y: year, m: month, d: day)

\* The default value may differ, depending on the transceiver version.

**MENU** » **SET > SD Card**

### SD Card Info

Displays the SD card capacity and the time remaining for voice recording.

### Screen Capture View

Displays the selected screen capture.

### TX/RX Picture View

Displays the pictures that are saved on the SD card.

- ① The transceiver cannot display the picture while transmitting picture data.
- ② The transceiver can display up to 500 pictures.

### Firmware Update

Displays the Firmware Update mode.

### Format

Formats the SD card.

If you use a brand new SD card, be sure to format it in the transceiver.

**MENU** » **SET > SD Card**

### Unmount

Unmounts the SD card.

Before you remove a card when the transceiver is ON, be sure to electrically unmount it. Otherwise the data may be corrupted or deleted.

## Others

**MENU** » SET > Others > **Information**

### Version

---

Displays the transceiver firmware's version number.

### MAC Address

---

Displays the transceiver's MAC address.

**MENU** » SET > Others > **Clone**

### Clone Mode

---

Selects to enter the clone mode to read or write the CS-9700 data from or to the PC.

① Restart the IC-9700 to cancel the clone mode.

**MENU** » SET > **Others**

### Touch Screen Calibration

---

Touch to adjust the touch screen.

① See the *Advanced Manual* for details.

**MENU** » SET > Others > **Reset**

### Partial Reset

---

Resets operating settings to their default values (VFO frequency, VFO settings, menu contents) without clearing the items below:

- Memory channel contents
- Call sign memories
- Message contents
- DTMF memory contents
- GPS memory contents
- Repeater list contents
- Network settings
- REF Adjust
- Fixed Edges
- Allowed call sign list contents
- Preset memory contents

① See "Resetting" (p. 10-2) for details.

### All Reset

---

Clears all data and returns all settings to their factory defaults.

Memory channel contents, filter setting and so on will all be cleared, so you will need to rewrite your operating settings.

① See "Resetting" (p. 10-2) for details.

## Setting the date and time

### ◇ Setting the date

1. Open the Date screen.

**MENU** » **SET > Time Set > Date/Time > Date**

2. Touch [+] or [-] to set the date.
3. Touch [SET] to save the date.

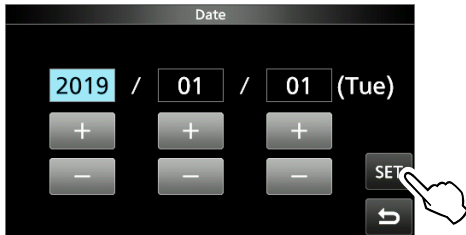

4. To close the DATE/TIME screen, push **EXIT** several times.

### ◇ Setting the current time

1. Open the Time screen.

**MENU** » **SET > Time Set > Date/Time > Time**

2. Touch [+] or [-] to set the current time.
3. Touch [SET] to save the time.

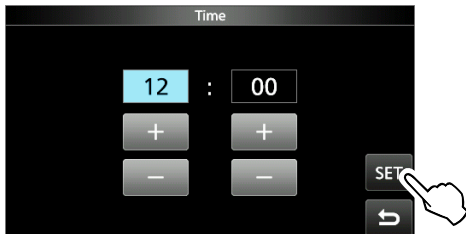

4. To close the DATE/TIME screen, push **EXIT** several times.

### ◇ Setting the UTC offset

1. Open the UTC Offset screen.

**MENU** » **SET > Time Set > UTC Offset**

2. Touch [+] or [-] to set the UTC offset.
3. Touch **↩** to save the UTC offset.

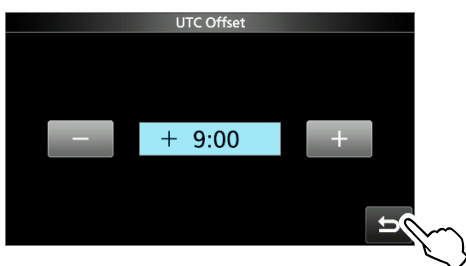

4. To close the TIME SET screen, push **EXIT** several times.

## NTP function

The NTP (Network Time Protocol) function synchronizes the internal clock with the time management server.

① To use this function, an internet connection and default gateway settings are necessary.

### ◇ Using the NTP Time Synchronize function

Using this function you can manually synchronize the internal clock by accessing the time management server.

1. Open the DATE/TIME screen.

**MENU** » **SET > Time Set > Date/Time**

2. Touch “<<NTP TIME SYNC>>.”

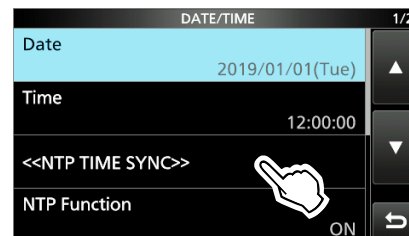

- “NTP Time Sync. Please wait...” is displayed.
  - The transceiver starts accessing the NTP server address that is set in the “NTP Server Address” item.
3. When “Time Sync completed.” is displayed, touch [OK].
  4. To close the DATE/TIME screen, push **EXIT** several times.

### ◇ Using the NTP function

By turning ON the NTP function, the transceiver automatically synchronizes the internal clock with the time management server.

1. Open the DATE/TIME screen.

**MENU** » **SET > Time Set > Date/Time**

2. Touch “NTP Function.”

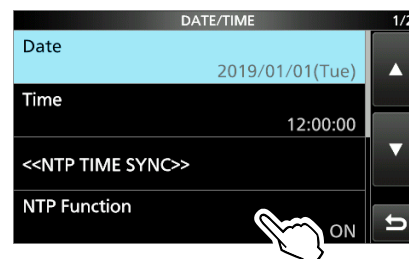

3. Select ON or OFF.
  - When ON is selected, the transceiver starts accessing the NTP server address that is set in the “NTP Server Address” item.
4. To close the DATE/TIME screen, push **EXIT** several times.

# 10 MAINTENANCE

## Cleaning



**DO NOT** use harsh solvents such as benzine or alcohol when cleaning, because they will damage the transceiver surfaces.



If the transceiver becomes dusty or dirty, wipe it clean with a dry, soft cloth.

## Replacing fuse

If a fuse blows, or the transceiver stops functioning, find and repair the cause of the problem. Then replace the damaged fuse with a new, adequately rated fuse.

① Spare fuses are supplied with the transceiver.

The fuses are installed in the DC power cable and in the inside circuitry, to protect the transceiver.

- DC power cable fuses .....ATC 32 V 25 A
- Circuitry fuse .....APS 58 V 5 A

### ⚠ WARNING!

- Disconnect the DC power cable from the transceiver before replacing the fuse.
- **NEVER** use fuses that are not specified.

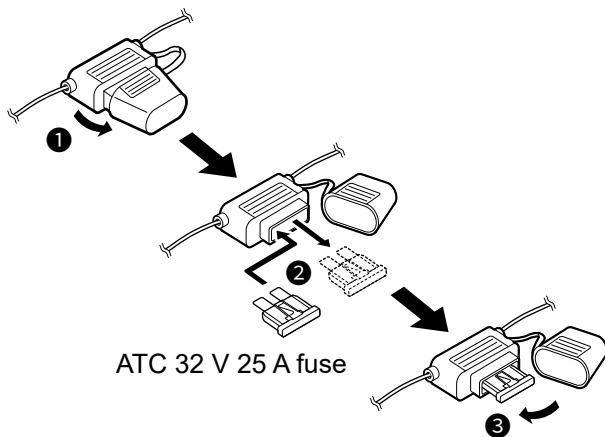

### Fuse Coding explanation

Fuse Coding: FUSE 32 V 25 A  
Fuse Voltage Rating: 32 Volts  
Fuse Current Rating: 25 Amperes

1. Remove the 18 screws, then remove the cover.

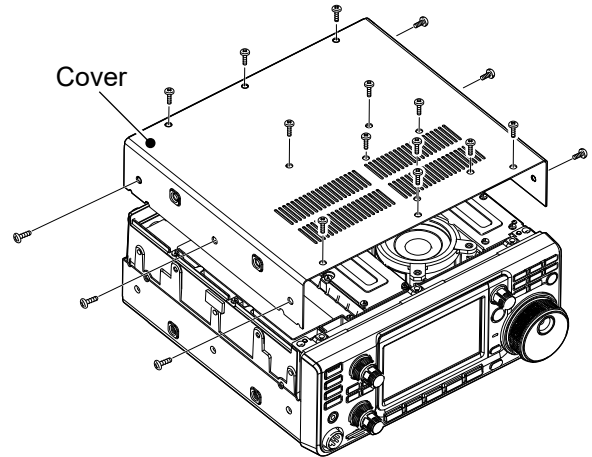

2. Remove the 13 shield screws, then remove the shield cover.

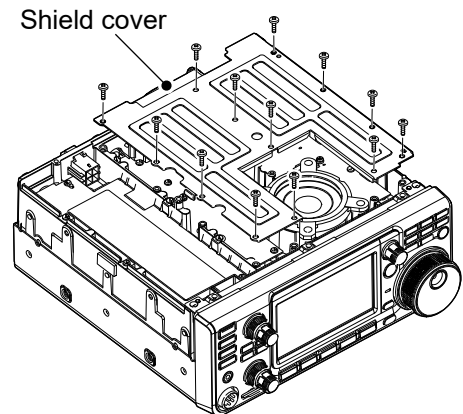

3. Replace the circuitry fuse as shown below.

**CAUTION:** When you remove a fuse, use longnose pliers to protect your fingers and the fuse holders.

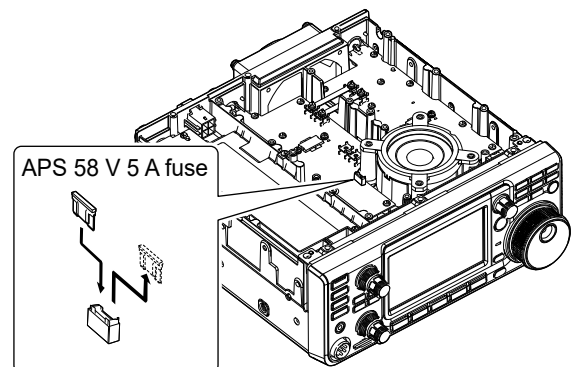

4. Replace the removed parts.

## Resetting

Occasionally, erroneous information may be displayed. This may be caused by static electricity or by other factors.

If this problem occurs, turn OFF the transceiver. After waiting a few seconds, turn ON the transceiver again. If the problem still exists, perform a **Partial reset**, as described to the right.

If the problem still exists after a Partial reset, perform an **All reset**, also described to the right.

**NOTE:** An All reset clears all data and returns all settings to their factory defaults. Save memory channel content, setting status, and so on, onto an SD card before an All reset. (p. 10-2)

### Partial reset

Partial reset resets operating settings to their default values (VFO frequency, VFO settings, and menu contents) without clearing the items listed below:

- Memory channel contents
- Call sign memories
- Message contents
- DTMF memory contents
- GPS memory contents
- Repeater list contents
- Network settings
- REF Adjust
- Fixed Edges
- Allowed call sign list contents
- Preset memory contents

### All reset

All reset clears all data and returns all settings to their factory defaults.

Memory channel contents, filter settings and so on will all be cleared, so you will need to rewrite your operating settings, unless you have a backup.

#### When you cannot enter the Set mode

If a touch screen operation error or an unexpected operation occurs, you cannot enter the Set mode. In this case, execute an All reset, as described below:

1. Turn OFF the transceiver.
2. While holding down **PBT** and **V/M**, push **POWER**.
- ① If you cannot turn the transceiver ON or OFF by using **POWER**, perform an All reset by connecting an external power source while holding down **PBT** and **V/M**.

### ◇ Partial reset

1. Open the RESET screen.

**MENU** » **SET > Others > Reset**

2. Touch "Partial Reset."



- The confirmation screen is displayed.

3. Touch [YES].

① After resetting, the default VFO mode screen is displayed.

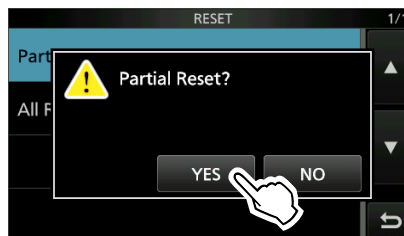

### ◇ All reset

1. Open the RESET screen.

**MENU** » **SET > Others > Reset**

2. Touch "All Reset."



- The confirmation screen is displayed.

3. Touch [NEXT].

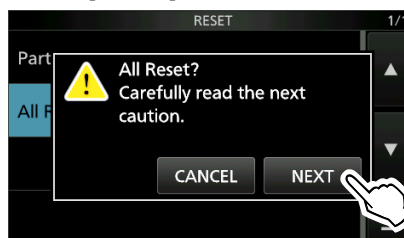

4. After carefully reading the displayed message, touch [YES] to perform the All reset.

① After resetting, the default VFO mode screen is displayed.



## Cloning

The IC-9700 has a data cloning capability. This function is useful when you want to copy all of the entered contents from one IC-9700 to another. This section describes the cloning method using an SD card.

- ① Recorded voice memories are not included in the cloning data. To play back the master transceiver's voice memory, insert the SD card into a sub transceiver, or make a copy onto the sub transceiver's SD card using a PC.
- ① Assumes that the SD card has already been inserted into the transceiver.

### Step 1. Saving the master transceiver's setting data onto the SD card.

- Open the SAVE SETTING screen.  
**MENU** » **SET > SD Card > Save Setting**

- Touch "<<New File>>."

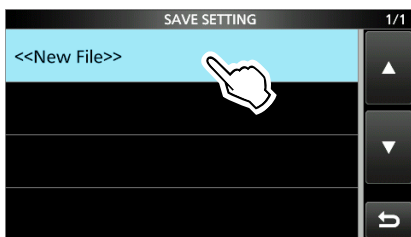

- ① The file name is automatically set in the following format: Setyyyyymmdd\_xx (yyyy: Year, mm: month, dd: day, xx: serial number).
- To save the file with the displayed name, touch **[ENT]**.

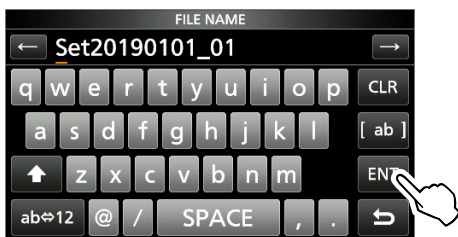

- ① If you want to change the name, delete the name and reenter it, and then touch **[ENT]**.
- Touch **[YES]**.
    - Saves the data settings.

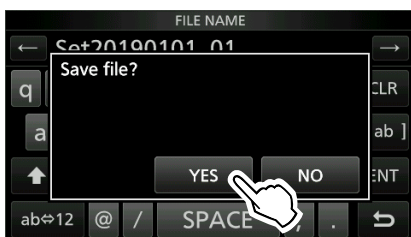

- To close the SD CARD screen, push **[EXIT]** several times.

### Step 2. Remove the SD card from the master transceiver, then insert it into the sub transceiver.

- Turn OFF the master transceiver.
- Remove the SD card from the master transceiver.
- Insert the SD card into the sub transceiver, then turn ON the sub transceiver.

**NOTE:**

- Turn OFF the transceiver before you attach or detach the SD card.
- **DO NOT** turn OFF the transceiver while saving or loading the setting data. Otherwise the data may be corrupted or deleted.

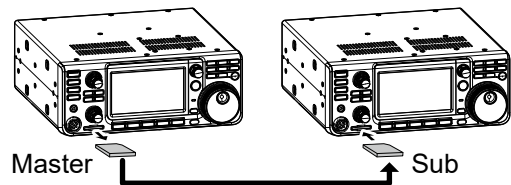

**TIP:** The setting data are saved in the "icf" file format that is used in the CS-9700 PROGRAMMING SOFTWARE.

When the saved data on a card is copied to a PC, you can edit it with the programming software. For details, refer to the CS-9700 instructions that can be downloaded from the Icom website.

(Continue the steps on the next page.)

Cloning (Continued)

**Step 3. Loading the setting data into the sub transceiver.**

1. Open the LOAD SETTING screen.  
**MENU** » **SET > SD Card > Load Setting**

2. Touch the file to load.

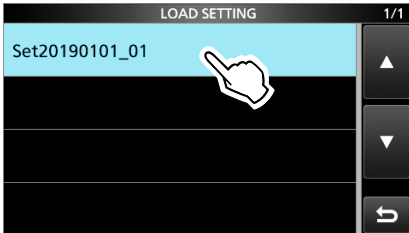

3. Touch "Select."

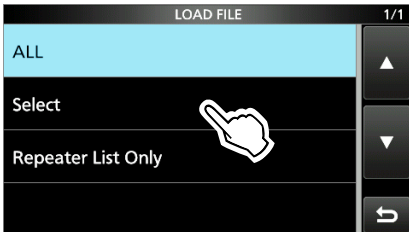

- ① If you want to load all the contents on the LOAD OPTION screen, touch "ALL" and go to step 6.
- ① If you want to load only the repeater list, touch "Repeater List Only" and go to step 6.

4. Touch the loading options. (Example: CI-V Address)

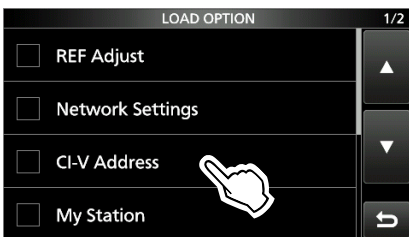

- "✓" is displayed left side of the selected option.
- ① The Set mode settings and Memory channel contents are always loaded.

5. Touch "<<Load>>."

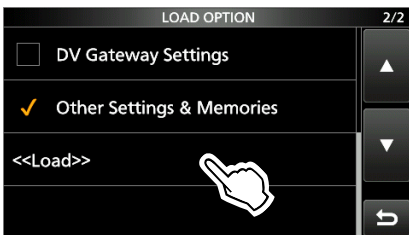

6. Touch [YES] or [NO].

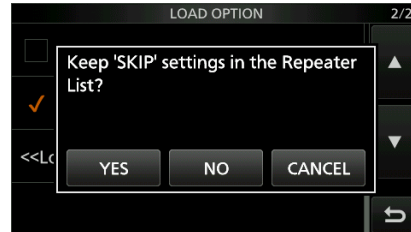

- "Load file ?" is displayed.
  - ① When you touch [YES], the skip settings of the repeater list are retained.
  - ① When you touch [NO], the skip settings of the repeater list are cleared.
7. Touch [YES].
    - After the loading ends, "COMPLETED! Restart the IC-9700." is displayed.
    - ① When you select "REF Adjust" in step 4, "The new "REF Adjust" setting will be saved" is displayed.
  8. Turn OFF the transceiver power, then turn it ON again to restart the transceiver.

## Touch screen calibration function

When no screen action occurs, or a different function is activated after touching the screen, the touched point and the detected point may be different. In that case, the Touch screen calibration function helps to correct the touch screen sensing accuracy.

1. Open the OTHERS screen.

**MENU** » **SET > Others**

2. Touch "Touch Screen Calibration."
  - A dot appears on the screen.

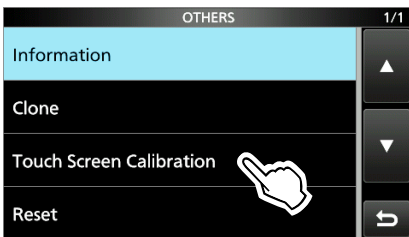

3. Touch the dot that is displayed on the screen.
  - A new dot appears in another position.

Touch the displayed dot



4. Repeat step 3.
  - ① When the calibration is complete, the transceiver returns to the OTHERS screen.

**TIP: When the touch screen is not accurate, and you cannot access the OTHERS screen.**

Do the following steps to display the "Touch Screen Calibration" screen.

1. Turn OFF the transceiver.
2. While holding down **MENU** and **EXIT**, push **POWER** to display the "Touch Screen Calibration" screen.
3. Repeat step 3 and 4 on the left column.
4. Touch the frequency readout or a key on the touch screen to confirm that the touch screen is working correctly.

## Troubleshooting

The following chart is designed to help you solve problems that are not equipment malfunctions.

If you are unable to locate the cause of a problem, or solve it through the use of this chart, contact your nearest Icom Dealer or Service Center.

PROBLEM	POSSIBLE CAUSE	SOLUTION	REF.
Power does not turn ON when <b>POWER</b> is pushed.	The power cable is not connected properly.	Reconnect the DC power cable properly.	p. 2-1
	The external power supply is turned OFF.	Turn ON the external power supply.	
	The DC power cable fuses or circuitry fuse are blown.	Find and repair the cause of the problem, and then replace the damaged fuse with a new one.	p. 10-1
No sound is heard from the speaker.	The function that mutes the received audio of the SUB band is turned ON.	Turn OFF the Sub Band Mute function.	p. 8-3
	The audio level is too low.	Rotate <b>(AF↔RF/SQ)</b> (inner) clockwise to obtain a suitable listening level.	p. 3-1
	The squelch is closed.	Rotate <b>(AF↔RF/SQ)</b> (outer) to the 12 o'clock position to open the squelch.	
	Headphones are connected.	Disconnect the headphones.	p. 1-1
	In the FM mode, the Tone Squelch function is turned ON.	Turn OFF the Tone Squelch function.	–
Sensitivity is too low, and only strong signals are heard.	The attenuator is activated.	Turn OFF the attenuator.	p. 4-1
	RF gain control is activated. ( <b>RFG</b> is displayed.)	Set the RF gain higher until RFG just goes off. ( <b>RFG</b> disappears.)	p. 3-10
	The antenna is defective or the coaxial cable is defective.	Repair the problem and then reconnect the antenna.	p. 13-3
	You are using an antenna that is not suitable for the band you have selected.	Connect an antenna suitable for the operating band.	
	The squelch is closed.	Rotate <b>(AF↔RF/SQ)</b> (outer) to the 12 o'clock position to open the squelch.	p. 3-10
The transceiver automatically switches to transmit while receiving.	The VOX function is ON.	Push <b>(VOX/BK-IN)</b> to turn OFF the VOX function.	–
	The VOX gain is set too high.	Adjust the VOX gain.	
No power output or the output power is too low.	The transmit output power is set too low.	Adjust the RF POWER in the Multi-function menu.	p. 3-10
	The modulation input signal level is set too low.	Adjust the microphone gain in Multi-function menu.	p. 3-11
	The output power is limited because of power amplifier protection.	Stop transmitting, and then wait without turning off the transceiver until the temperature of the power amplifier FET drops sufficiently.	p. 3-10
	The microphone is bad, or the [MIC] connector is shorted or defective.	Test the microphone and check the [MIC] connector.	p. 13-3
	The antenna SWR is more than 3:1.	Adjust the antenna for an SWR of less than 3:1.	p. 3-11
Transmit signal is unclear or distorted in the SSB mode.	The transceiver's microphone gain is too high.	Adjust the MIC GAIN level so that the meter reading swings between 30 and 50% of the ALC scale.	p. 3-11
	The desktop microphone gain is too high.		
Received audio in the SSB mode is unclear or distorted.	The incorrect sideband is selected.	Toggle between USB and LSB.	p. 3-3
	The PBT function is activated.	Hold down <b>(MULTI)</b> , and then set to clear.	p. 4-3

## Troubleshooting (Continued)

PROBLEM	POSSIBLE CAUSE	SOLUTION	REF.
In the VFO mode, the operating frequency is not properly changed by rotating <b>(MULTI)</b> .	The function assigned to <b>(MULTI)</b> is wrong.	Push <b>(MHz)</b> , and then rotate <b>(MULTI)</b> .	p. 1-7
Cannot contact with another station, even if receiving and transmitting seem normal.	The transmit and receive frequencies are different because of the Split function. ( <b>(SPLIT)</b> is displayed.)	Push <b>(SPLIT)</b> to turn OFF the Split function.	p. 4-9
	A different receive or transmit frequency is set because of the RIT function. ( <b>(RIT)</b> is displayed.)	Push <b>(RIT)</b> to turn OFF the RIT function.	p. 4-1
There is no response after transmitting.	Duplex function is ON, and the transmit and receive frequencies are different.	Turn OFF the Duplex function.	—
The operating frequency is not properly changed by rotating <b>(MAIN DIAL)</b> .	The Dial Lock function is ON.	Hold down <b>(SPEECH)</b> to turn the Dial Lock function OFF.	p. 3-10
Display turns off.	The Screen Saver function is ON. (The <b>(POWER)</b> lamp blinks green.)	Operate something (push key, and so on) to reset the screen saver startup time.	p. 8-20
Programmed scan does not start.	The same frequencies have been set in scan edge memory channels (1A/1B ~ 3A/3B).	Set different frequencies in scan edge memory channels.	—
Memory scan does not start.	No, or only 1 memory channel is set.	Set at least 2 memory channels.	—
Select memory scan does not start.	No, or only 1 memory channel is designated as a Select channel.	Designate at least 2 memory channels as Select channels for the scan.	—
The contents of a selected memory channel is not changed.	The contents of the selected memory channel were changed, but they were not saved.	When you want to save the changed settings, touch [MW] for 1 second to write them into the memory channel on the VFO/MEMORY screen.	—
Cannot hear the speech after pushing <b>(SPEECH)</b> .	The speech level is too low.	Adjust "SPEECH Level" in the Speech setting.	p. 8-4
<b>(OVF)</b> is displayed.	An excessively strong signal is received.	Rotate <b>(AF/RFSQL)</b> (outer) counter clockwise. ( <b>(RF)</b> is displayed.)	p. 3-10
		Turn ON the attenuator.	p. 4-1
		Turn OFF the Preamp (P.AMP OFF).	p. 4-1
Spectrum scope's sensitivity is too low, and only strong signals are displayed.	The reference level is too low.	Set the reference level to a higher level.	p. 5-1
Cannot transmit voice memories.	"DATA OFF MOD" is set to "ACC," "USB," or "LAN" by control from an external device, and so on.	Set "DATA OFF MOD" to "MIC,ACC" (default).	p. 8-15
Cannot save TX/RX histories or sound data.	An SD card is not inserted.	Insert an SD card.	p. 6-1
"No SD card is found." is displayed.	An SD card is not recognized.	<ul style="list-style-type: none"> <li>• Confirm that an SD card is inserted.</li> <li>• Reinsert an SD card.</li> <li>• Exchange with a new SD card.</li> </ul>	p. 6-1
The touch screen is not working correctly.	The touched point and the detected point may be different.	Calibrate the touch screen in the OTHERS screen.	p. 8-23

Troubleshooting (Continued)

PROBLEM	POSSIBLE CAUSE	SOLUTION	REF.
The current time is reset.	The transceiver has not been used for a long time with the DC power cable disconnected.	Connect the transceiver to the power supply for 2 days (approximate) to charge backup battery of the internal clock.	p. 8-21
The clock is not set automatically.	The transceiver is not connected to the internet.	Confirm the [LAN] port connection.	p. 13-2
	The transceiver IP address is wrong.	Get the IP address automatically, or set the correct IP address.	p. 8-18

◇ D-STAR operation

To communicate through a repeater, your signal must access to the repeater. The following chart is designed to help you correct problems which are not equipment malfunctions.

PROBLEM	POSSIBLE CAUSE	SOLUTION	REF.
After your call, the repeater does not return a status reply.	A repeater setting is incorrect.	<ul style="list-style-type: none"> <li>Select the correct repeater.</li> <li>Correct the repeater frequency, frequency offset, or duplex settings.</li> </ul>	—
	Your transmission did not reach the repeater.	<ul style="list-style-type: none"> <li>Wait until you are closer to the repeater and try again.</li> <li>Try to access another repeater.</li> </ul>	—
After your call, the repeater replies 'UR?' and its call sign.	The call was successfully sent, but no station immediately replied.	Wait for a while, and try again.	—
After your call, the repeater replies 'RX' or 'RPT?' and the access repeater's call sign.	Your own call sign (MY) has not been set.	Set your own call sign (MY).	—
	Your own call sign (MY) has not been registered on a gateway repeater, or the registered contents do not match your transceiver's settings.	Register your own call sign (MY) on a gateway repeater, or confirm the registration of the call sign.	—
After your call, the repeater replies 'RPT?' and the access repeater's call sign.	The call sign of the destination repeater is wrong.	Correctly set the destination repeater call sign.	—
After your call, the repeater replies 'RPT?' and the destination repeater's call sign.	The repeater cannot connect to the destination repeater.	Check the repeater settings.	—
	The repeater is busy.	Wait for a while, and try it again.	—
Even holding down <b>CALLDR</b> , the DR screen is not displayed.	There is no repeater list in your transceiver.	<ul style="list-style-type: none"> <li>Import the repeater using an SD card.</li> <li>Directly enter the Repeater list data into the transceiver.</li> </ul>	—
	The Lock function is activated.	Hold down <b>SPEECH</b> for 1 second to turn OFF the Lock function.	—
Even push <b>TONE(RX-CS)</b> , the received call sign will not set to the destination call sign.	The call sign has not been correctly received.	Try it again, after the transceiver has correctly received the call sign.	—
	When a received signal is weak, or a signal is received during scanning, the call sign may not be received correctly. In that case, "-----" is displayed and error beeps sound, and a reply call cannot be made.		

## 10 MAINTENANCE

### Troubleshooting (Continued)

PROBLEM	POSSIBLE CAUSE	SOLUTION	REF.
A Local area call can be made, but the Gateway call or destination station call cannot be made.	MY call sign has not been registered on a D-STAR repeater.	Register your own call sign (MY) on a gateway repeater, or confirm the registration of the call sign.	8-6
	The repeater set in "FROM" (Access Repeater) has no Gateway.	Check the repeater settings.	—
"L" is displayed on the LCD.	While receiving through the internet, some packets may be lost due to network error (poor data throughput performance).	Wait a while, and try it again. ①When the transceiver receives corrupted data, and misidentifies it as Packet Loss, "L" is displayed, even if it is a Local area call.	—
"DV" and "FM" icons alternately blink.	While in the DV mode, an FM signal is received.	Use a different operating frequency until there are no FM signals on the original frequency.	—

## ◇ General

- Frequency coverage (unit: MHz):
 

USA Version	Receiver/Transmitter	144.000000 ~ 148.000000
		430.000000 ~ 450.000000
		1240.000000 ~ 1300.000000
EUR Version	Receiver/Transmitter	144.000000 ~ 146.000000
		430.000000 ~ 440.000000
		1240.000000 ~ 1300.000000
ITR Version	Receiver/Transmitter	144.000000 ~ 146.000000
		430.000000 ~ 434.000000
		435.000000 ~ 438.000000
		1240.000000 ~ 1245.000000
		1270.000000 ~ 1298.000000
TPE Version	Receiver/Transmitter	144.000000 ~ 146.000000
		430.000000 ~ 432.000000
		1260.000000 ~ 1265.000000
KOR Version	Receiver/Transmitter	144.000000 ~ 146.000000
		430.000000 ~ 440.000000
		1260.000000 ~ 1300.000000
- Operating modes: USB/LSB (J3E), CW (A1A), RTTY (F1B), AM (A3E), FM (F2D/F3E), DV (F7W), and DD (F1D)
- Number of memory channels: 297 channels (99 channels × 3 bands)
- Number of program scan channels: 18 channels (6 channels × 3 bands)
- Number of call channels: 6 channels (2 channels × 3 bands)
- Number of satellite memory channels: 99 channels
- Number of repeater memories: 2500
- Number of GPS memories: 300
- Antenna impedance: 50 Ω unbalanced
- Antenna connectors: SO-239 × 1 (for the 144 MHz band)  
Type-N × 2 (for the 430/1200 MHz band)
- Power supply requirement: 13.8 V DC (±15%)
- Operating temperature range: -10°C to +60°C, 14°F to 140°F
- Frequency stability: ±0.5 ppm or less (-10°C to +60°C, 14°F to 140°F)
- Frequency resolution: 1 Hz
- Power consumption:
 

Receive	Standby	1.2 A
	Maximum audio	1.8 A
Transmit	Maximum power	18.0 A
- Dimensions (projections not included): 240 (W) × 94 (H) × 238 (D) mm, 9.4 (W) × 3.7 (H) × 9.4 (D) in
- Weight (approximate): 4.7 kg, 10.4 lb

---

## 11 SPECIFICATIONS

### ◇ Transmitter

- Transmit output power:
  - 144 MHz bands
    - SSB/CW/FM/RTTY/DV 0.5 ~ 100 W
    - AM 0.125 ~ 25 W
  - 430 MHz bands
    - SSB/CW/FM/RTTY/DV 0.5 ~ 75 W
    - AM 0.125 ~ 18.75 W
  - 1200 MHz bands
    - SSB/CW/FM/RTTY/DV/DD 0.1 ~ 10 W
    - AM 0.025 ~ 2.5 W
- Modulation system:
  - SSB Digital PSN modulation
  - FM Digital Reactance modulation
  - AM Digital Low power modulation
  - DV Digital GMSK modulation
  - DD Digital GMSK modulation
- Spurious emission:
  - Harmonics
    - Less than -63 dB (144 MHz band)
    - Less than -61.8 dB (430 MHz band)
    - Less than -53 dB (1200 MHz band)
  - Out-of-band emission
    - Less than -60 dB (144/430 MHz band)
    - Less than -50 dB (1200 MHz band)
- Carrier suppression: More than 50 dB
- Unwanted sideband suppression: More than 50 dB
- Microphone impedance: 600  $\Omega$

◇ Receiver

- Receive system: 144/430 MHz band RF Direct Sampling  
1200 MHz band Down Conversion IF Sampling
- Intermediate frequency (1200 MHz band):  
USA/EUR Version 311 ~ 371 MHz  
ITR Version 311 ~ 316 MHz, 341 ~ 369 MHz  
TPE Version 331 ~ 336 MHz  
KOR Version 331 ~ 371 MHz
- Sensitivity (Filter: SOFT, P.AMP: ON, IP+: ON):  
SSB/CW (at 10 dB S/N) Less than -19 dBμV (0.11 μV)  
AM (at 10 dB S/N) Less than 0 dBμV (1.0 μV)  
FM (at 12 dB SINAD) Less than -15 dBμV (0.18 μV)  
DV (1% BER (PN9)) Less than -9 dBμV (0.35 μV)  
DD (1% BER (PN9)) Less than 4 dBμV (1.59 μV)
- Sensitivity for the European version (Filter: SOFT, P.AMP: ON, IP+: ON):  
SSB/CW (BW=2.4 kHz, 12 dB SINAD) Less than -6 dBμV emf  
AM (BW=4 kHz, 60% Modulation, 12 dB SINAD) Less than 0 dBμV emf  
FM (BW=7 kHz, 60% Modulation, 12 dB SINAD) Less than -6 dBμV emf
- Selectivity (Filter: SHARP):  
SSB (BW=2.4 kHz) More than 2.4 kHz/-3 dB  
Less than 3.6 kHz/-60 dB  
CW (BW=500 Hz) More than 500 Hz/-3 dB  
Less than 700 Hz/-60 dB  
RTTY (BW=500 Hz) More than 500 Hz/-3 dB  
Less than 700 Hz/-60 dB  
AM (BW=6 kHz) More than 6.0 kHz/-3 dB  
Less than 15 kHz/-60 dB  
FM (BW=15 kHz) More than 12.0 kHz/-6 dB  
Less than 20 kHz/-60 dB  
DV (Channel spacing=12.5 kHz) Less than -50 dB  
DD (Channel spacing=300 kHz) Less than -40 dB
- Spurious and image rejection:  
SSB/CW 144/430 MHz band More than 70 dB  
1200 MHz band More than 50 dB  
AM/FM/DV 144/430 MHz band More than 60 dB  
1200 MHz band More than 50 dB  
DD 1200 MHz band More than 50 dB
- Audio output power: More than 2.0 W (8 Ω load, 1 kHz, 10% distortion)
- AF output impedance: 8 Ω
- RIT variable range: ±9.999 kHz
- ANF attenuation: More than 30 dB (with 1 kHz single tone)
- MNF attenuation: More than 70 dB
- NR attenuation: More than 6 dB (noise rejection in SSB)

# 12 OPTIONS

## Options

(As of January 2026)

### HM-219 MICROPHONE

The same as supplied.



### SM-30

#### DESKTOP MICROPHONE

Desktop microphone with a low frequency cut function.



### SM-50

#### DESKTOP MICROPHONE

Dynamic microphone with [UP]/[DOWN] switches.



### SP-38

#### EXTERNAL SPEAKER

Designed to match the IC-9700.



### SP-41

#### EXTERNAL SPEAKER

Designed to match the IC-9700.



- **MB-118 MOUNTING BRACKET**  
To mount the transceiver inside a vehicle.
- **MB-123 CARRYING HANDLE**
- **OPC-2350LU DATA CABLE**
- **SP-33 EXTERNAL SPEAKER**  
Designed for base station operation.
- **SP-35 EXTERNAL SPEAKER**  
Designed for mobile operation.
- **CT-17 CI-V CONVERTER**  
For remote transceiver control using a PC equipped with an RS-232C port.
- **RS-BA1 Version 2 IP REMOTE CONTROL SOFTWARE**

**NOTE:** To remotely control transceivers using the RS-BA1, BE SURE to comply with your local regulations.

Approved Icom optional equipment is designed for optimal performance when used with an Icom transceiver. Icom is not responsible for the destruction or damage to an Icom transceiver in the event the Icom transceiver is used with equipment that is not manufactured or approved by Icom.

### About the free download software

You can download each manual and guide from the Icom website.

<https://www.icomjapan.com/support/>

Before using, read each manual and guide, and use it according to the instructions.

① To use to the software, the following items are required.

CS-9700 (For Windows)	PROGRAMMING SOFTWARE	SD card USB cable
RS-MS1A (For Android devices)	Android™ APPLICATION	OPC-2350LU
RS-MS3A (For Android devices)	TERMINAL MODE/ACCESS POINT MODE APPLICATION	
RS-MS3W (For Windows)	TERMINAL MODE/ACCESS POINT MODE SOFTWARE	
ST-4001A (For Android devices)	PICTURE UTILITY SOFTWARE	LAN cable
ST-4001W (For Windows)		
ST-4001I (For iOS)		
ST-4002A (For Android devices)	GPS SOFTWARE	OPC-2350LU
ST-4003A (For Android devices)	TIME ADJUSTMENT SOFTWARE	USB cable
ST-4003W (For Windows)		

① To add or expand a function, or to improve the performance, the software version may be upgraded. Before you update your software version, see the instructions and cautions described on the Icom website.

## Mounting the MB-118

Mount the MB-118 MOUNTING BRACKET to a place where it can be firmly attached.

① We recommend that you periodically check whether the screws are loose or not, especially after a long period of use.

**NOTE:**

- Before mounting the MB-118, carefully read PRECAUTIONS (p. vii) and decide the mounting place.
- **DO NOT** use bolts other than the ones that are supplied with the MB-118. Other bolts (longer than 8 mm/0.31 in) may damage the internal units.

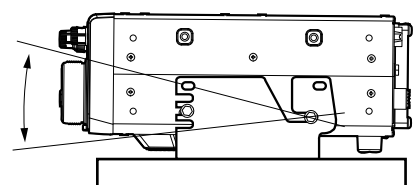
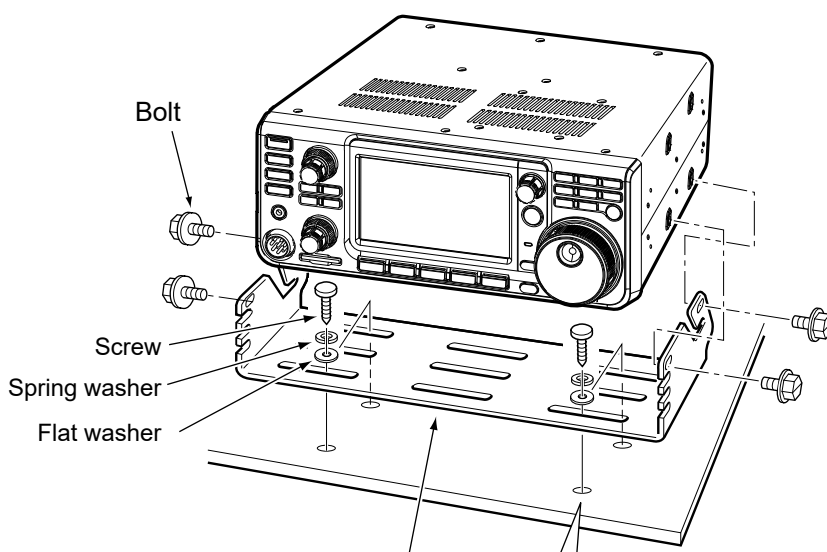

Adjust for the best viewing angle.

Drill 4 holes of 3 mm (0.12 in) for the bracket location.  
 ① Drill 5.5 mm~5.6 mm (0.21 in~0.22 in) holes when using the supplied hex screws.

## Attaching the MB-123

The optional MB-123 CARRYING HANDLE with the rubber feet is convenient for carrying the transceiver.

1. Attach the rubber feet supplied with the MB-123 to the transceiver.  
 ① To firmly attach, push-in the center part of the rubber feet.
2. Attach the carrying handle using the supplied screws, as shown to the right.

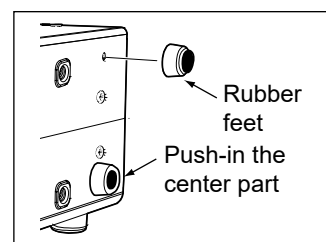

**NOTE: DO NOT** use other than the screws supplied with the MB-123.

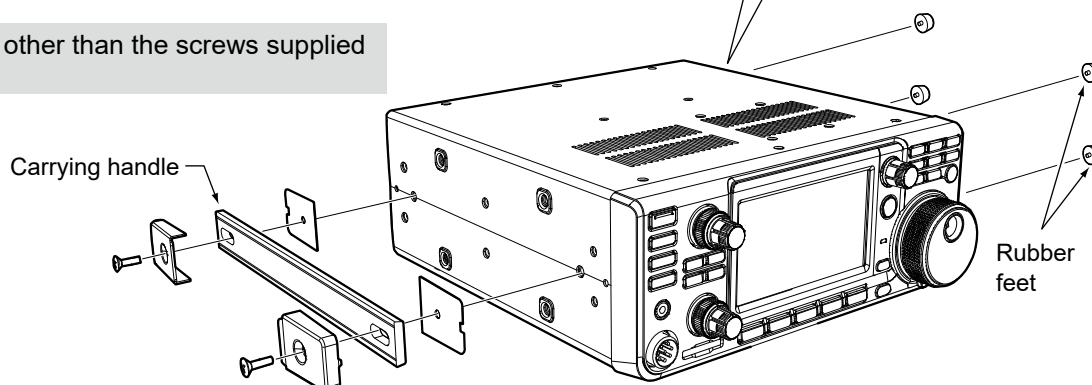

# 13 CONNECTOR INFORMATION

## [ACC]

Connects to external equipment or a PC to control an external unit or the transceiver.

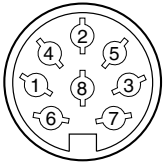
ACC 1	PIN No.	NAME	DESCRIPTION	SPECIFICATIONS
 <p>8-pin Rear panel view</p>	1	RTTY	Controls RTTY keying.	High level: More than 2.4 V Low level: Less than 0.6 V Output current: Less than 2 mA
	2	GND	Connects to ground.	—
	3	SEND*1	Input/output pin. An external unit controls the transceiver. When this pin goes to ground, the transceiver transmits. The pin goes low when the transceiver transmits.	Input voltage (RX): 2 ~ 20 V Input voltage (TX): -0.5 ~ +0.8 V Current flow: Maximum 20 mA Output voltage (TX): Less than 0.1 V Current flow: Maximum 200 mA
	4	MOD	Modulator input. Connects to the internal modulator circuit.	Input impedance: 10 kΩ Output level: Approx. 100 mV rms*2
	5	AF/IF (IF=12 kHz)*3	Fixed AF detector or receive IF (12 kHz) signal output.	Output impedance: 4.7 kΩ Output level: 100 ~ 300 mV rms*4
	6	SQL S	Squelch output. This pin goes to ground when the squelch opens (TX/RX indicator lights green).	SQL open: Less than 0.3 V/5 mA SQL closed: More than 6.0 V/100 μA
	7	13.8 V	13.8 V output when power is ON.	Output current: Maximum 1A
	8	ALC	ALC voltage input.	Input level: -4 ~ 0 V Input impedance: More than 10 kΩ

\*1 When the SEND terminal controls an inductive load, such as a relay, a counter-electromotive force can malfunction or damage the transceiver. To prevent this, we recommend adding a switching diode, such as an 1SS133, on the load side of the circuit to absorb the counter-electromotive force. When the diode is added, a delay in relay switching may occur. Be sure to check its switching action before operating.

(Example) ACC socket

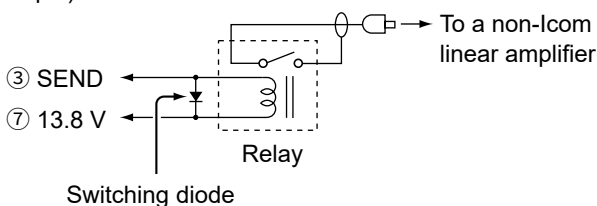

\*2 You can change the MOD input level.  
① 100 mV rms is at 50% as the default.

**MENU** » SET > Connectors > ACC MOD Level

\*3 You can change the AF/IF (IF=12 kHz) settings to output a 12 kHz IF signal. In that case.

**MENU** » SET > Connectors > ACC Output Select

\*4 You can change the AF/IF (IF=12 kHz) output level.  
① Approximately 200 mV rms is at the 50% as the default.

**MENU** » SET > Connectors > ACC IF Output Level

## [PHONES]

Connects to standard stereo headphones:

- Output impedance: 8 ~ 16 Ω
- Output level: More than 5 mW into an 8 Ω load.

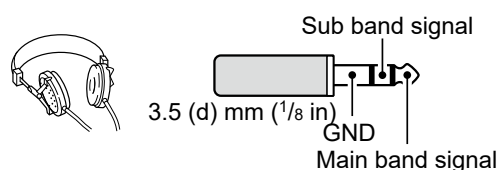

- ① The internal speaker is deactivated while an external speaker is connected.
- ① When high impedance headphones are used, the audio output level may be too high.
- ① You can change the headphone output setting.

**MENU** » SET > Connectors > Phones > LR/ Mix ACC MOD Level

## [DC 13.8 V]

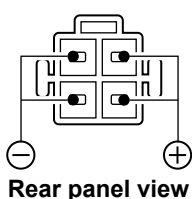

Accepts the regulated DC power for 13.8 V DC ±15% through the supplied DC power cable.

**⚠ WARNING! NEVER reverse the DC power cable polarity.**

## [KEY]

Connects to a Paddle key or Straight key.

① You can select the key type.

**MENU** » SET > KEYER > EDIT/SET > CW-KEY SET > Key Type

• Paddle key

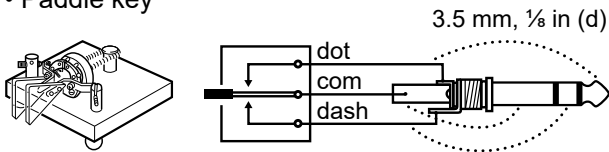

• Straight key

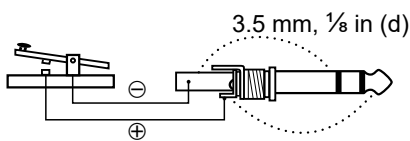

## [EXT-SP MAIN] / [EXT-SP SUB]

Connects to external speakers.

3.5 mm, 1/8 in (d)

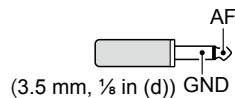

- Output impedance: 4 ~ 8 Ω
- Output level: More than 2 W at 10% distortion into an 8 Ω load.

**Audio output settings** (When [PHONES] is not in use)

	Internal speaker	EXT-SP MAIN	EXT-SP SUB
<b>Internal speaker</b>	MAIN/SUB	OFF	OFF
<b>External speaker (MAIN+SUB)</b>	OFF	MAIN*	SUB*
<b>External speaker (MAIN)</b>	SUB	MAIN*	OFF
<b>External speaker (SUB)</b>	MAIN	OFF	SUB*

\* When the [External Speaker Separate] item is set to "Mix," the audio from both MAIN and SUB are output, and the internal speaker is deactivated.

**MENU** » SET > Connectors > External Speaker Separate

### ① Information

- The internal speaker is deactivated while an external speaker is connected.
- [EXT-SP A] is for the Main band and [EXT-SP B] is for the Sub band.

**MENU** » SET > Connectors > EXT-SP MAIN/SUB Mix

## [USB]

USB (1.1/2.0) type B



- Outputting the decoded RTTY data.
- Outputting the demodulated AF signal or 12 kHz IF signal.
- Inputting the modulation AF signal.
- Interface for remote control by CI-V commands.
- Cloning the setting data using the CS-9700 software.
- Remotely controlling using optional RS-BA1.

① You can change the signal output type and output level.

**MENU** » SET > Connectors > USB AF/IF Output

① You can download the USB driver and installation guide from the Icom website.

[https://www.icomjapan.com/support/firmware\\_driver/](https://www.icomjapan.com/support/firmware_driver/)

## [LAN]

- Time synchronization by an NTP server.
- Outputting the demodulated AF signal or 12 kHz IF signal.
- Remotely controlling using optional RS-BA1.
- Gateway communication (D-STAR)
- Data communication (DD mode)
- Picture transferring from a PC or a mobile device.
- Monitoring a DV repeater

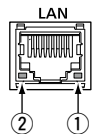

① You can select the output signal from AF and IF signals.

**MENU** » SET > Connectors > LAN AF/IF Output

### About the LED indication

#### ① LINK/ACT

- Lights when a cable is connected.
- Does not light when a cable is not connected.
- Blinks while communicating.

#### ② Speed

- Lights while communicating in 100BASE-TX.
- Does not light while communicating in 10BASE-T, or not connected.

## [DATA]

Connects a PC through a data communication cable (user supplied), for data communication, DV Gateway functions or remote controlling by CI-V commands.

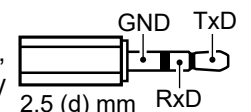

Using the optional communication cable, you can use the RS-MS1A application.

Connecting a GPS unit (NMEA compatible) or GPS output compatible Icom transceiver (Example: ID-31PLUS) enables the received position data to be displayed on the IC-9700's display.

# 13 CONNECTOR INFORMATION

## [MIC]

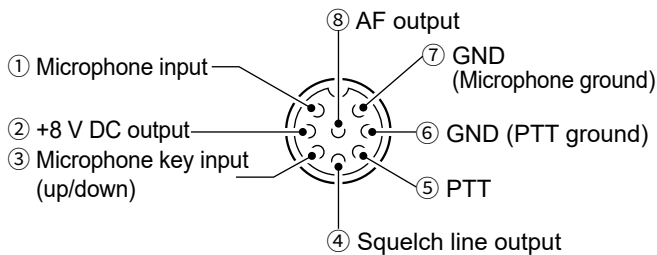

**NOTE:** Pin 1 outputs 8 V DC power for Icom microphones.

PIN No.	DESCRIPTION
①	Microphone input
②	+8 V DC output (Maximum 10 mA)
③	Microphone key input (Up/Down)
④	Grounded when the squelch opens.
⑤	PTT*
⑥	PTT ground
⑦	Microphone ground
⑧	AF output from [EXT-SP MAIN] / [EXT-SP SUB] (Varies with the AF control.)

\* The [PTT] switch function can be customized in the following item.

**MENU** » SET > Connectors > **PTT Port Function**

By connecting an external keypad with a circuit as shown below to [MIC], you can output memory content from 4 memories. You can output memory contents such as that from a CW Memory keyer (M1 ~ M4), SSB/AM/FM/DV Voice Memory (T1 ~ T4) or RTTY Memory (RT1 ~ RT4) to be transmitted.

- Push a switch to send memory contents.
- Hold down the switch for 1 second to repeatedly send memory contents.

① To use the external keypad, turn ON the following items.

**MENU** » SET > Connectors > **External Keypad**

① The External keypad is not supplied by Icom.

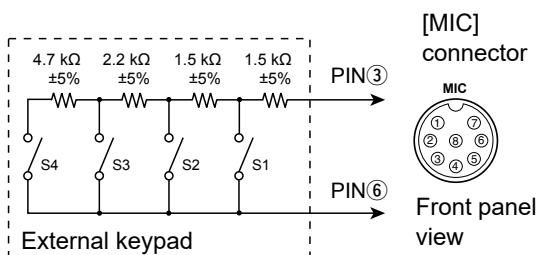

① Memory "RT5 ~ RT8" (RTTY), "T5 ~ T8" (Voice) and "M5 ~ M8" cannot be sent from the external keypad.

## [REMOTE]

Connects to a PC for remote control using CI-V commands.

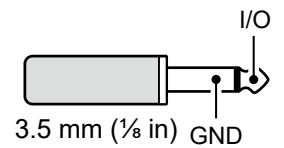

## [REF IN 10MHz]

Inputs a 10 MHz signal as a reference frequency signal.



SMA connector

- Input frequency: 10 MHz
- Impedance: 50 Ω (unbalanced)
- Input level: -10 dBm (approximate)

① Adjust the internal reference frequency.

**MENU** » SET > Function > **REF Adjust**

## [144MHz ANT]

Connect an antenna for the 144 MHz band. (SO-239)

- Input/Output impedance: 50 Ω (unbalanced)

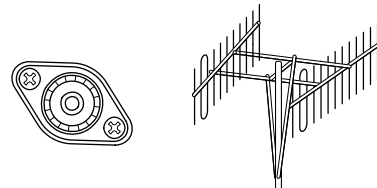

## [430MHz ANT]

Connect an antenna for the 430 MHz band. (Type N)

- Input/Output impedance: 50 Ω (unbalanced)

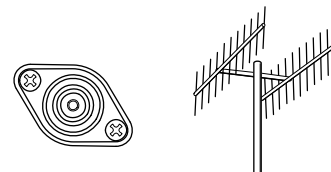

## [1200MHz ANT]

Connect an antenna for the 1200 MHz band. (Type N)

- Input/Output impedance: 50 Ω (unbalanced)

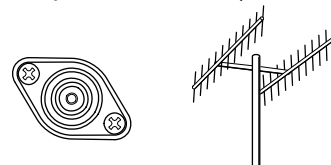

### ⚠ WARNING!

A DC voltage can be applied to the antenna coax connector to power an external preamplifier. Be careful when you connect a preamplifier (user supplied).

① To use an antenna preamplifier, select "ON" for each band.

**MENU** » SET > Connectors > **External P.AMP**

# ABOUT THE LICENSES

Information on the open source software being used by this product.

COPYRIGHT NOTICE, DISCLAIMER, and LICENSE:

If you modify libpng you may insert additional notices immediately following this sentence.

This code is released under the libpng license.

libpng versions 1.2.6, August 15, 2004, through 1.6.12, June 12, 2014, are Copyright (c) 2004, 2006-2014 Glenn Randers-Pehrson, and are distributed according to the same disclaimer and license as libpng-1.2.5 with the following individual added to the list of Contributing Authors:

Cosmin Truta

libpng versions 1.0.7, July 1, 2000, through 1.2.5, October 3, 2002, are Copyright (c) 2000-2002 Glenn Randers-Pehrson, and are distributed according to the same disclaimer and license as libpng-1.0.6 with the following individuals added to the list of Contributing Authors:

Simon-Pierre Cadieux  
Eric S. Raymond  
Gilles Vollant

and with the following additions to the disclaimer:

There is no warranty against interference with your enjoyment of the library or against infringement. There is no warranty that our efforts or the library will fulfill any of your particular purposes or needs. This library is provided with all faults, and the entire risk of satisfactory quality, performance, accuracy, and effort is with the user.

libpng versions 0.97, January 1998, through 1.0.6, March 20, 2000, are Copyright (c) 1998, 1999, 2000 Glenn Randers-Pehrson, and are distributed according to the same disclaimer and license as libpng-0.96, with the following individuals added to the list of Contributing Authors:

Tom Lane  
Glenn Randers-Pehrson  
Willem van Schaik

libpng versions 0.89, June 1996, through 0.96, May 1997, are Copyright (c) 1996, 1997 Andreas Dilger Distributed according to the same disclaimer and license as libpng-0.88, with the following individuals added to the list of Contributing Authors:

John Bowler  
Kevin Bracey  
Sam Bushell  
Magnus Holmgren  
Greg Roelofs  
Tom Tanner

libpng versions 0.5, May 1995, through 0.88, January 1996, are Copyright (c) 1995, 1996 Guy Eric Schalnat, Group 42, Inc.

For the purposes of this copyright and license, "Contributing Authors" is defined as the following set of individuals:

Andreas Dilger  
Dave Martindale  
Guy Eric Schalnat  
Paul Schmidt  
Tim Wegner

The PNG Reference Library is supplied "AS IS". The Contributing Authors and Group 42, Inc. disclaim all warranties, expressed or implied, including, without limitation, the warranties of merchantability and of fitness for any purpose. The Contributing Authors and Group 42, Inc. assume no liability for direct, indirect, incidental, special, exemplary, or consequential damages, which may result from the use of the PNG Reference Library, even if advised of the possibility of such damage.

Permission is hereby granted to use, copy, modify, and distribute this source code, or portions hereof, for any purpose, without fee, subject to the following restrictions:

1. The origin of this source code must not be misrepresented.
2. Altered versions must be plainly marked as such and must not be misrepresented as being the original source.
3. This Copyright notice may not be removed or altered from any source or altered source distribution.

The Contributing Authors and Group 42, Inc. specifically permit, without fee, and encourage the use of this source code as a component to supporting the PNG file format in commercial products. If you use this source code in a product, acknowledgment is not required but would be appreciated.

A "png\_get\_copyright" function is available, for convenient use in "about" boxes and the like:

```
printf("%s", png_get_copyright(NULL));
```

Also, the PNG logo (in PNG format, of course) is supplied in the files "pngbar.png" and "pngbar.jpg (88x31)" and "pngnow.png" (98x31).

Libpng is OSI Certified Open Source Software. OSI Certified is a certification mark of the Open Source Initiative.

The contributing authors would like to thank all those who helped with testing, bug fixes, and patience. This wouldn't have been possible without all of you.

Thanks to Frank J. T. Wojcik for helping with the documentation.

License for CMSIS-RTOS RTX Implementation

Copyright (c) 1999-2009 KEIL, 2009-2013 ARM Germany GmbH All rights reserved.

Redistribution and use in source and binary forms, with or without modification, are permitted provided that the following conditions are met:

- Redistributions of source code must retain the above copyright notice, this list of conditions and the following disclaimer.
- Redistributions in binary form must reproduce the above copyright notice, this list of conditions and the following disclaimer in the documentation and/or other materials provided with the distribution.
- Neither the name of ARM nor the names of its contributors may be used to endorse or promote products derived from this software without specific prior written permission.

THIS SOFTWARE IS PROVIDED BY THE COPYRIGHT HOLDERS AND CONTRIBUTORS "AS IS" AND ANY EXPRESS OR IMPLIED WARRANTIES, INCLUDING, BUT NOT LIMITED TO, THE IMPLIED WARRANTIES OF MERCHANTABILITY AND FITNESS FOR A PARTICULAR PURPOSE ARE DISCLAIMED. IN NO EVENT SHALL COPYRIGHT HOLDERS AND CONTRIBUTORS BE LIABLE FOR ANY DIRECT, INDIRECT, INCIDENTAL, SPECIAL, EXEMPLARY, OR CONSEQUENTIAL DAMAGES (INCLUDING, BUT NOT LIMITED TO, PROCUREMENT OF SUBSTITUTE GOODS OR SERVICES; LOSS OF USE, DATA, OR PROFITS; OR BUSINESS INTERRUPTION) HOWEVER CAUSED AND ON ANY THEORY OF LIABILITY, WHETHER IN CONTRACT, STRICT LIABILITY, OR

TORT (INCLUDING NEGLIGENCE OR OTHERWISE) ARISING IN ANY WAY OUT OF THE USE OF THIS SOFTWARE, EVEN IF ADVISED OF THE POSSIBILITY OF SUCH DAMAGE.

## ZLIB DATA COMPRESSION LIBRARY

zlib 1.2.8 is a general purpose data compression library. All the code is thread safe. The data format used by the zlib library is described by RFCs (Request for Comments) 1950 to 1952 in the files <http://tools.ietf.org/html/rfc1950> (zlib format), [rfc1951](http://tools.ietf.org/html/rfc1951) (deflate format) and [rfc1952](http://tools.ietf.org/html/rfc1952) (gzip format).

All functions of the compression library are documented in the file `zlib.h` (volunteer to write man pages welcome, contact [zlib@gzip.org](mailto:zlib@gzip.org)). A usage example of the library is given in the file `test/example.c` which also tests that the library is working correctly. Another example is given in the file `test/minigzip.c`. The compression library itself is composed of all source files in the root directory.

To compile all files and run the test program, follow the instructions given at the top of `Makefile.in`. In short "`./configure; make test`", and if that goes well, "`make install`" should work for most flavors of Unix. For Windows, use one of the special makefiles in `win32/` or `contrib/vstudio/`. For VMS, use `make_vms.com`.

Questions about zlib should be sent to [zlib@gzip.org](mailto:zlib@gzip.org), or to Gilles Vollant [info@winimage.com](mailto:info@winimage.com) for the Windows DLL version. The zlib home page is <http://zlib.net/>. Before reporting a problem, please check this site to verify that you have the latest version of zlib; otherwise get the latest version and check whether the problem still exists or not.

PLEASE read the zlib FAQ [http://zlib.net/zlib\\_faq.html](http://zlib.net/zlib_faq.html) before asking for help.

Mark Nelson [markn@ieee.org](mailto:markn@ieee.org) wrote an article about zlib for the Jan. 1997 issue of Dr. Dobbs's Journal; a copy of the article is available at <http://marknelson.us/1997/01/01/zlib-engine/>.

The changes made in version 1.2.8 are documented in the file `ChangeLog`.

Unsupported third party contributions are provided in directory `contrib/`.

zlib is available in Java using the `java.util.zip` package, documented at <http://java.sun.com/developer/technicalArticles/Programming/compression/>.

A Perl interface to zlib written by Paul Marquess [pmqs@cpan.org](mailto:pmqs@cpan.org) is available at CPAN (Comprehensive Perl Archive Network) sites, including <http://search.cpan.org/~pmqs/IO-Compress-Zlib/>.

A Python interface to zlib written by A.M. Kuchling [amk@amk.ca](mailto:amk@amk.ca) is available in Python 1.5 and later versions, see <http://docs.python.org/library/zlib.html>.

zlib is built into `tc`: <http://wiki.tcl.tk/4610>.

An experimental package to read and write files in .zip format, written on top of zlib by Gilles Vollant [info@winimage.com](mailto:info@winimage.com), is available in the `contrib/minizip` directory of zlib.

Notes for some targets:

- For Windows DLL versions, please see `win32/DLL_FAQ.txt`
- For 64-bit Irix, `deflate.c` must be compiled without any optimization. With
- O, one libpng test fails. The test works in 32 bit mode (with the `-n32` compiler flag). The compiler bug has been reported to SGI.

- zlib doesn't work with gcc 2.6.3 on a DEC 3000/300LX under OSF/1 2.1 it works when compiled with cc.

- On Digital Unix 4.0D (formerly OSF/1) on AlphaServer, the `cc` option `-std1` is necessary to get `gzprintf` working correctly. This is done by `configure`.

- zlib doesn't work on HP-UX 9.05 with some versions of `/bin/cc`. It works with other compilers. Use "make test" to check your compiler.

- `gzdopen` is not supported on RISCOS or BEOS.

- For PalmOs, see <http://palmzlib.sourceforge.net/>

## Acknowledgments:

The deflate format used by zlib was defined by Phil Katz. The deflate and zlib specifications were written by L. Peter Deutsch. Thanks to all the people who reported problems and suggested various improvements in zlib; they are too numerous to cite here.

## Copyright notice:

(C) 1995-2013 Jean-loup Gailly and Mark Adler

This software is provided 'as-is', without any express or implied warranty. In no event will the authors be held liable for any damages arising from the use of this software.

Permission is granted to anyone to use this software for any purpose, including commercial applications, and to alter it and redistribute it freely, subject to the following restrictions:

1. The origin of this software must not be misrepresented; you must not claim that you wrote the original software. If you use this software in a product, an acknowledgment in the product documentation would be appreciated but is not required.
2. Altered source versions must be plainly marked as such, and must not be misrepresented as being the original software.
3. This notice may not be removed or altered from any source distribution.

Jean-loup Gailly Mark Adler  
[jloup@gzip.org](mailto:jloup@gzip.org) [madler@alumni.caltech.edu](mailto:madler@alumni.caltech.edu)

If you use the zlib library in a product, we would appreciate "not" receiving lengthy legal documents to sign. The sources are provided for free but without warranty of any kind. The library has been entirely written by Jean-loup Gailly and Mark Adler; it does not include third-party code.

If you redistribute modified sources, we would appreciate that you include in the file `ChangeLog` history information documenting your changes. Please read the FAQ for more information on the distribution of modified source versions.

# INDEX

	Number and symbol
1/4 Tuning function .....	3-5
<b>A</b>	
Accessories .....	i
AFC function .....	4-8
AGC function .....	4-2
Attenuator .....	4-1
Audio scope .....	5-3
Auto Tuning Step function .....	3-5
<b>B</b>	
Band Edge .....	3-7
Band Edge Beep .....	3-6
Band stacking register .....	3-3
Break-in function .....	4-11
<b>C</b>	
Cleaning .....	10-1
Clock	
Current time .....	9-1
Date .....	9-1
UTC offset .....	9-1
Cloning .....	10-3
Connecting	
DC power supply .....	2-1
Connector .....	13-1
Connectors (Set mode) .....	8-14
CW	
Operating .....	4-10
Pitch control .....	4-10
Side tone .....	4-11
<b>D</b>	
Data mode .....	3-3
Desktop stands .....	2-1
Dial Lock function .....	3-10
Digital Twin PBT .....	4-3
Display .....	1-4
Display (Set mode) .....	8-19
Dualwatch operation .....	3-2
DV/DD Set (Set mode) .....	8-9
DV Repeater Monitor Set (Set mode) .....	8-10
<b>E</b>	
Electronic Keyer function .....	4-12
Entering	
Example .....	1-10
Keyboard .....	1-9
Exporting a CSV .....	6-6
<b>F</b>	
Features .....	i
FFT scope .....	5-3
Filter	
IF filter .....	4-4
Notch Filter .....	4-6
Transmit filter width .....	4-10
<b>G</b>	
Fine Tuning function .....	3-4
Frequency	
Directly entering .....	3-5
Using the Main Dial .....	3-4
Function (Set mode) .....	8-2
<b>H</b>	
Grounding .....	2-1
<b>I</b>	
Heat dissipation .....	2-1
<b>J</b>	
<b>K</b>	
Keyboard	
Entering and editing .....	1-8
Keyboard types .....	1-9
<b>L</b>	
<b>M</b>	
Main band .....	3-2
Memory mode .....	3-1
MENU screen .....	1-6
Meter .....	3-11
Microphone gain .....	3-11
Monitor function .....	4-7
Multi-function	
Dial .....	1-7
Menus .....	1-7
My Station (Set mode) .....	8-6
<b>N</b>	
Network (Set mode) .....	8-18
Noise Blanker .....	4-5
Noise Reduction .....	4-6
NTP function .....	9-1
<b>O</b>	
Operating band .....	3-3
Operating mode .....	3-3
Options .....	12-1
Oscilloscope .....	5-3
Others (Set mode) .....	8-23
<b>P</b>	
Panel	
Front .....	1-1
Rear .....	1-3
Touch screen .....	1-4
Power	
Applying .....	3-1
ON or OFF .....	3-1
Preamplifiers .....	4-1

Q

QSO/RX Log (Set mode)..... 8-11

QUICK MENU..... 1-6

R

Replacing fuse..... 10-1

Resetting

    All reset ..... 10-2

    Partial reset ..... 10-2

RF gain ..... 3-10

RIT function ..... 4-1

S

Satellite communications

    Loop test..... 7-2

    Memories..... 7-3

    Mode ..... 7-1

    Operation..... 7-3

    Outline ..... 7-1

    Tracking..... 7-1

SD card

    Deleting ..... 6-4

    Folders ..... 6-7

    Formatting ..... 6-1

    Information ..... 6-4

    Inserting..... 6-1

    Loading..... 6-3

    Saving ..... 6-2

    Unmounting ..... 6-2

SD Card (Set mode)..... 8-22

Set mode ..... 8-1

    Connectors ..... 8-14

    Display..... 8-19

    DV/DD Set..... 8-9

    DV Repeater Monitor Set ..... 8-10

    Function..... 8-2

    My Station ..... 8-6

    Network ..... 8-18

    Others..... 8-23

    QSO/RX Log ..... 8-11

    SD Card..... 8-22

    Time Set ..... 8-21

    Tone Control/TBW ..... 8-2

Specifications ..... 11-1

Spectrum scope

    Center mode..... 5-1, 5-2

    Fixed mode..... 5-1, 5-2

    Marker ..... 5-2

    Mini scope ..... 5-3

    Scroll mode ..... 5-1, 5-2

    Touch screen ..... 5-3

Speech Compressor..... 4-8

Split frequency operation..... 4-9

Split Lock function ..... 4-10

SQL level ..... 3-10

Squelch

    Noise ..... 3-10

    S-meter..... 3-10

Sub band ..... 3-2

T

Time Set (Set mode) ..... 8-21

Tone Control/TBW (Set mode) ..... 8-2

Touch screen calibration function ..... 10-5

Transmit output power..... 3-10

Transmit Power Limit function ..... 3-10

Troubleshooting..... 10-6

Tuning Step function..... 3-4

V

VFO mode ..... 3-1

Volume level ..... 3-1

